

DNP

Card Printer

CX-D80

Electronic Manual

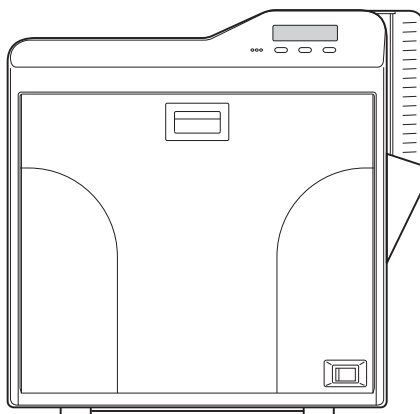

Thank you for purchasing this product.
Please read through this "Electronic Manual"
carefully in advance to ensure proper use of the
product. Also, to make sure that the product is
used safely, please read through the "Safety
Precautions" in the "READ ME FIRST" booklet.
Please store the manuals properly after reading
so that they can be referred to whenever
necessary.

LST1008-002D

Contents

Before Use

About this Manual	3
Precautions	3
Disclaimer	7
Name and Functions of Parts	7
Specifications	10
Accessories/Products Sold Separately	10
Options	11

Operating the Printer

Printing a Card	12
Operation Panel	13
Setting Mode	15
Sequence of Setting Modes	17
Factory Settings	19
Security Lock	20
Setting Using the Operation Panel	22
Setting Using the Status Monitor	30

Replacement

Cards	31
Ink Ribbon	32
Retransfer Film	33

Maintenance

Servicing of Parts	35
Servicing Based on Print Output	43

Troubleshooting

When an Error Message is Displayed	44
Cards	46
Ink Ribbon	54
Retransfer Film	56
Unable to Produce Desired Printing Results	57
Printer not Operating as Desired	58
Before Sending Printer for Repair	58

Setup

Installation and Connection	59
Printing Media	60
Printer and Computer Connection	64
Computer Settings	65
Software	65
Install	65
Uninstall	82
IPSec	87
Printer Driver Settings	90
Port Monitor Settings	110
Status Monitor Settings	111
Inline Encoding	123
List of Error Codes	125
Frequently Asked Questions	128

About this Manual

Contents of this Manual

- The copyright of this manual belongs to our company. Reprint and duplicate of this manual in part or full without the prior consent of our company is strictly prohibited.
- Product names of other companies described in the manual are the trademarks or registered trademarks of the respective companies. Symbols such as ™, ® and © are omitted in this manual.
- Designs, specifications, or other details described in this manual may be modified for improvement without prior notice.
- Microsoft and Windows are either registered trademarks or trademarks of Microsoft Corporation in the United States and /or other countries. Microsoft® Windows® 8 operating system, Microsoft® Windows® 7 operating system, Microsoft® Windows Vista™ operating system, Microsoft® Windows® XP operating system and Microsoft® Windows® 2000 operating system are represented as Windows 8, Windows 7, Windows Vista, Windows XP and Windows 2000 respectively in this manual.
- Microsoft product screen shot(s) reprinted with permission from Microsoft Corporation.
- This product includes software developed by the OpenSSL Project for use in the OpenSSL Toolkit. (<http://www.openssl.org/>) This product includes cryptographic software written by Eric Young (eay@cryptsoft.com). This product includes software written by Tim Hudson (tjh@cryptsoft.com).

How to Read this Manual



- Information in this frame is for reference purposes, such as information on functions and usage restrictions.



- Precautions are described in this frame.



- Click this frame to display the details page.



- Click this icon to return to the top page.

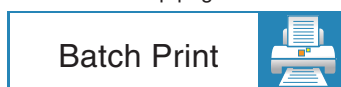

- Click this icon to open the PDF files for all items. The "Adobe Reader" application is needed to browse the PDF file.



- Click this icon to open the PDF file for the displayed item. The "Adobe Reader" application is needed to browse the PDF file.

Precautions

Safety Precautions

- Please read through all the following items before using the printer.

Graphical Symbols

- A number of graphical symbols are used in this manual as well as on the printer. They are intended to ensure the safe use of this product, protect users against safety hazards, as well as prevent damage of property. Make sure that you read through this manual after gaining a proper understanding of the symbols' meaning.



- If you ignore the warning with this mark, and handle the unit in a wrong way, death or serious injuries may occur.



- If you ignore the caution with this mark, and handle the unit in a wrong way, injuries or damages to properties may occur.

Warnings



■ **If the abnormal phenomena as listed below are seen, immediately stop operating the unit. Continuing operation may cause a fire or electric shock.**

- Smoke or odd smell comes out from the machine.
- Water or metal went into the machine.
- The unit fell to the floor, or the cabinet was broken.
- The power cable is damaged (exposed lead, broken cable, etc.)

If you see these phenomena, turn off the power, pull out the power plug, and contact your dealer as soon as possible. Do not try to repair it by yourself. It is dangerous.

■ **Do not remove the screws, or disassemble or alter the machine.**

- High-voltage components are contained in the unit. Touching these areas may result in an electric shock.
- Ask your dealer if you want your printer inspected or repaired.
- Do not remove the external covers of the machine. You may get an electric shock.

■ **Do not work on the power cable, or give excessive force on it. Do not put heavy objects such as furniture on the cable.**

- The cable may be damaged, causing a fire or electric shock.
- When you find a defect on the power cable, such as exposed lead, stop using the unit, and consult your dealer.

■ **Do not use the machine with the power plug inserted incompletely.**

- The machine generates heat due to incomplete contact, causing a fire or electric shock.
- Do not put many cords on a single plug socket. The power cords also heats up.

■ **Do not use the machine with dusts piled on the power plug. Do not put a metallic material adjacent to the power plug.**

- Dusts and metal are conductive, causing a fire or electric shock.
- Pull out the power plug from the outlet every six months, and clean the dusts piled on the legs and body of the plug.

■ **Do not use a line voltage other than instructed.**

- Using a line voltage or power supply which is not specified may cause a fire or electric shock.

■ **Do not put foreign materials from the openings of the machine (e.g., vents, card slots, cassette inlet, etc.)**

- Metals, flammable things, and other foreign materials may cause a fire or electric shock if entering into the machine.
- If these things went into the machine, immediately turn off the power, pull out the power plug, and ask your dealer to repair. Do not try to repair it by yourself. It is dangerous.

■ **Do not put a container with liquid in it, or small metal ornaments and the like on the machine.**

- The liquid or metal entering into the machine acts as a conductor, causing a fire or electric shock.
- If liquid or metal went into the machine, immediately turn off the power, pull out the power plug, and ask your dealer to repair. Do not try to repair it by yourself. It is dangerous.

■ **Do not place the machine on a rickety table or slanting places.**

- The machine may fall out of the table or fall over, which may damage the machine or injure you.
- If the machine is damaged by falling or turnover, immediately turn off the power, pull out the power plug, and ask your dealer to repair. Do not try to repair it by yourself. It is dangerous.

■ **Do not wet the machine with water.**

- Using the machine at a place where water splashes on the machine, or wetting the machine with water (applying, throwing, or spilling water over the machine) may cause a fire or electric shock.
- If water entered into the machine, immediately turn off the power, pull out the power plug, and ask your dealer to repair. Do not try to repair it by yourself. It is dangerous.

■ **Do not touch the machine with wet hands.**

- Touching the machine with wet hands may cause an electric shock.

■ **Do not use the printer when cards are jammed inside.**

- Cards may not be discharged correctly such as when the retransfer setting for the card is inappropriate. Stop using and remove the jammed cards immediately. Otherwise, you may have problems removing the cards, and fire or electric shock may also occur as a result.

■ **Do not touch the power plug during electrical storms.**

- Lightning may cause an electric shock.

■ **Ground the machine with the attached electric cord when connecting it to the utility outlet.**

- Using a cord other than the one supplied for grounding may cause an electric shock when the machine fails.

■ **Do not put your head or yourself into the packaging bag.**

- Do not play with the packaging bag. You may suffocate yourself.
- Give close attention to small children who may want to play with the packaging bag.

■ **Do not use the machine while it has a fault.**

- Do not use the machine while it has a fault, as this may cause a fire or electric shock.
- Immediately turn off the power, pull out the power plug, and ask your dealer to repair. Do not try to repair it by yourself. It is dangerous.

■ **Keep the mounting part of a cardiac pacemaker away from the machine.**

- Radio waves used by the RF-ID function inside the printer system may affect the operation of the cardiac pacemaker.

Caution



■ **Pull out the power plug before cleaning the machine.**

- This is for preventing electric shocks.

■ **Pull out the power plug when you won't use the machine for a prolonged period of time to assure safety.**

- Remove the power plug from the outlet for safety when you won't use the machine for a long time.

■ **Do not move the machine with the power cable and other electric cables connected.**

- The cables may be damaged while being moved, which may cause a fire or electric shock.
- You may stumble over the cable and get injured.

■ **Do not move the machine with objects placed on it.**

- They may fall on you and hurt you.

■ **Do not put heavy objects on the machine.**

- They may fall on you and hurt you.

■ **Do not block the vents.**

- Heat generated inside the machine cannot escape, which may cause a fire.

■ **Do not rest your body on the machine, or leave it suspended above the ground.**

- The machine may drop, causing damage or injury. Pay particular attention when there are young children around.

■ **Be sure to work with two persons when you unpack, move or lift the machine.**

- If you work alone, you may be injured by the fallen machine or hurt your back by lifting a heavy machine by yourself.

■ **Inspection**

- Ask your dealer or a qualified person to inspect the machine, typically once every two to three years. Operating the machine with dusts piling on the components for a prolonged period of time may cause a fire or a malfunction of the machine. It will be particularly effective to inspect the machine before wet rainy season. Consult your dealer on the costs of inspection.

■ **Do not place the machine in the following locations.**

Doing so may cause fire or electric shock.

- Places that are highly humid or dusty.
- Places that are exposed to oily smoke or steam, such as near a cooking table or humidifier.
- Places near a heating equipment.
- Places that are subject to water droplet condensation, such as beside a window.

Also, placing it at a place that is exposed to direct sunlight may result in deterioration of the cabinet.

■ **Hold the body of the power plug when pulling it out.**

- Do not pull out the plug by holding the cable. The cable may be broken or damaged which may in turn cause a fire or electric shock.

■ **Do not touch the power plug with a wet hand**

- You may get an electric shock.

■ **Do not lay the power cable near the heating equipment.**

- The covering of the cable will melt due to heat from such equipment, which may cause a fire or electric shock.

■ **The heat rollers and adjacent areas become hot during operation.**

- Be careful not to touch the heat rollers and adjacent areas when replacing the ink ribbon or retransfer film, or remove jammed cards.
- Wait until the heat rollers get cooled down to prevent burns.

■ **Be careful not to catch your fingers in the card bracket of the card hopper, printer door and others.**

- Do not catch your fingers when replenishing the cards, attaching the ink ribbon and retransfer film, or when removing the card from the card hopper. It may cause injury.

■ **Be sure to use the power cord supplied with this printer.**

- Using a power cord that is of a different voltage or a damaged power cord will result in fire or electric shock.

■ **The power cord should be used only with this printer.**

- Do not use the power cord with products other than this printer. Doing so may result in fire or electric shock.

■ **When installing or moving the printer, hold the bottom (handle) of the printer with one hand on each side.**

- Carrying the printer by its corners or front and back may result in catching your fingers in between the printer and the floor or table.

Precautions During Use

- Please read through all the following items before using the printer.

Printer Installation

- When the printer is not in use, it is recommended that you turn off the power, and use a cover that is large enough to cover up the entire printer unit.
- Do not place the printer unit in the following locations. Doing so may have adverse effects on the printer.
 - Carpeted room.
 - Places with a busy flow of people.
 - Places where paper (corrugated boards, etc.) is handled or stored.
 - Places near photocopiers.
 - Places exposed to direct sunlight or near a heating equipment (such as a stove).
 - Inclined or unstable surfaces.
 - Places exposed directly to cold air, such as near an air-conditioner outlet, or places subject to high temperatures.
- When installing the printer, ensure there is sufficient space around the printer. (Install the printer by allowing a clearance of at least 20 cm between its sides and surrounding walls. Allow a clearance of at least 10 cm between the rear of the printer and the wall.)
- When installing or moving the printer, hold the bottom (handle) of the printer with one hand on each side to avoid jamming your hands or fingers.

■ Canceling the transport mode

- While in the transport mode during installation, the retransfer film cannot be loaded. If the printer is turned on without loading the retransfer film, a [Film Search] message appears and the transport mode is canceled.

■ During transport or moving of the printer

- Make sure to set to the transport mode.
- "Transport Mode Setting" (☞ page 29)

Precautions on Retransfer Film/Ink Ribbon/Card

■ Handling instructions

Pay careful attention of the following when handling a printing media (retransfer film or ink ribbon) or card.

- Using a deformed or scratched card may cause card feed errors.
- Touching the printing surface of the printing media or card directly with your hand may cause the print to turn out uneven.
- Foreign particles attached to the printed areas may result in printing voids. Install the printing media or card in a clean environment.
- Use of electrically-charged printing media or cards may cause printing errors. Do not allow static to occur, such as due to cards rubbing against each other.
- When replacing or replenishing a printing media or card that is stored under a low temperature, use after leaving the media or card in the operating ambient temperature of the printer for at least one hour. Otherwise, condensation may occur, causing printing errors or malfunction of the printer.

■ Storage instructions

- The storage conditions of the printing media (retransfer film or ink ribbon) and card have a significant effect on the printing quality. Store the printing media or card in one of the following locations.

■ Storage environment

- Temperature: 5 °C to 25 °C
- Relative humidity: 40 % to 60 %

■ Storage location

Do not store the printing media or card in the following locations. Doing so may cause the media or card to deteriorate.

- Places exposed to direct sunlight.
- Places with a high temperature and humidity.
- Places near organic solvents or diazo copiers.

■ Storage period

- Use the printing media (retransfer film or ink ribbon) within one year after purchase. For details on the cards, please consult our authorized dealers.

Precautions on Retransfer Film/Ink Ribbon

- Put on the supplied gloves when handling the retransfer film/ink ribbon. Direct contact of your hand with the printing surface may result in printing errors.

■ When retransfer film/ink ribbon is dismantled

- Winding misalignment may occur. If an improperly wound retransfer film/ink ribbon is loaded, printing failure or error may occur.

■ When loading the retransfer film/ink ribbon

- Use your hands to adjust the media at the supply and take-up sides so that they are parallel to each other. When doing so, make sure you do not touch the printing surface.
- Refer to the label adhered to the cassette for alignment of the image position. Printing errors may occur if the position is not properly aligned.

Winding misalignment

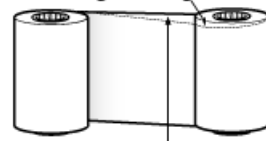

Adjust the position with your hands so that the media position is parallel at the take-up and supply sides

Precautions on Cards

- Put on the supplied gloves when handling the cards. Direct contact of your hand with the printing surface of the card may result in printing errors.

■ Handling and storage of cards after printing

Avoid storing cards at places that are exposed to direct sunlight or subject to high temperature and humidity.

Discoloration or fading may occur if a card comes into contact with the following chemicals or stationery.

- Organic solvents, including alcohol, film cleaner, and diazo copies.
- Files, document cases, pass holders, or erasers made of flexible polyvinyl chloride.
- Hair wax or cosmetic products.

■ Card types

Thin cards and certain card materials may not be suitable for printing using this printer. For details on the card material to use and other specifications, please consult our authorized dealers in advance.

Cautions:

- If the card thickness is not properly adjusted, printing error or printer malfunction may occur.

"Adjusting card thickness" (☞ page 63)

■ When a card is jammed inside the printer

Cards may not be discharged correctly such as when the retransfer setting for the card is inappropriate.

Stop using and remove the jammed cards immediately. Otherwise, you may have problems removing the cards, and fire or electric shock may also occur as a result.

- When a card is jammed, remove it according to the procedure described in the Electronic Manual.
- If the card cannot be removed, do not try to do so forcibly. Consult our authorized dealers or the servicing personnel.

Disclaimer

■ We do not provide compensation for any malfunction during card printing caused by breakdown of the machine, ink ribbon defects or card characteristics. In addition, we also do not provide compensation for insufficient print quality as a general rule. Please evaluate carefully beforehand.

■ Card Material

Some card material may not be suitable for printing. Using a contact-type IC card other than those specified by the dealer, may cause damage to the thermal head. No compensation is made for the life reduction and failures that were caused by unsuitable card material. Warp of card or uneven thickness of IC cards, even though they are within the tolerance of JIS or ISO standards, may not be suitable for printing or feeding. For details on the specifications about card material or others, consult the dealer in advance

■ Version upgrade

The following defects may occur as a result of the version upgrade for the firmware of the printer or for the printer driver.

- Card printing is disabled for the application software that has been used.
- The operation of the printer or application software becomes unstable.
- Defects in print result occurs.
- Print color or shade differs.
- The performance of reproducing fine letters, changes.
- Others

Be sure to retain a copy of the current version when performing version upgrade. Reinstall the previous version immediately if these problems occur. We are not liable for any damage such as defective cards or interruptions during printing as a result of the version upgrade.

Name and Functions of Parts

Internal Mechanism Diagram

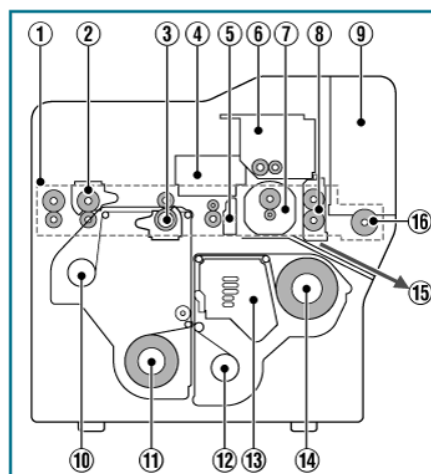

- ① Card feeder unit
 - This is the roller for feeding cards.
- ② Bend remedy unit (optional)
 - Corrects bending of the card after retransfer.
- ③ Retransfer heating roller
 - Transfers images printed on the retransfer film to the card.
- ④ Non-contact IC encoder (optional)
 - Writes data to a non-contact IC card.
- ⑤ Contact section of contact IC encoder (optional)
 - Writes data to a contact IC card.
- ⑥ Magnetic encoder (optional)
 - Writes data to a magnetic stripe card.
- ⑦ Card turn over unit (double-sided printer only)
 - Inverts the card.
- ⑧ Cleaning roller
 - Removes dust or dirt attached to the card.
- ⑨ Card hopper
 - For loading cards.
- ⑩ Retransfer film (take-up side)
 - For attaching the take-up side of the retransfer film.
- ⑪ Retransfer film (supply side)
 - For attaching the unused side of the retransfer film.
- ⑫ Ink ribbon (take-up side)
 - For attaching the take-up side of the ink ribbon.
- ⑬ Thermal head
 - Prints images on the retransfer film.
- ⑭ Ink ribbon (supply side)
 - For attaching the unused side of the ink ribbon.
- ⑮ NG card outlet
 - Discharges NG cards, such as during card jams.
- ⑯ Card load roller
 - Roller for loading cards.

Front

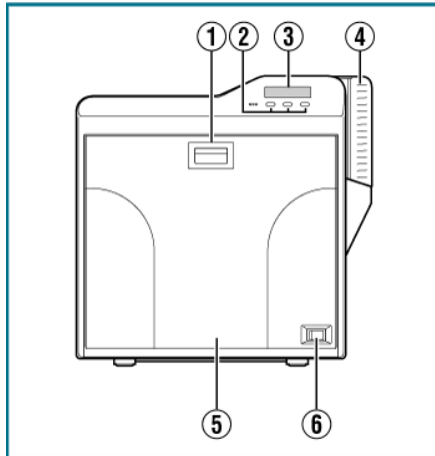

- ① Sliding knob
 - Opens/closes the printer door.
 - Slide it upward, and pull toward you to open the printer door.
- ② Operation buttons
 - For selecting and confirming information on the operation panel.
- ③ Operation panel
 - Displays the settings, operating status, and error messages.
- ④ Card hopper
 - For loading cards.
- ⑤ Printer door
 - Turns the power On/Off.
- ⑥ Power switch
 - Turns the power On/Off.

Right

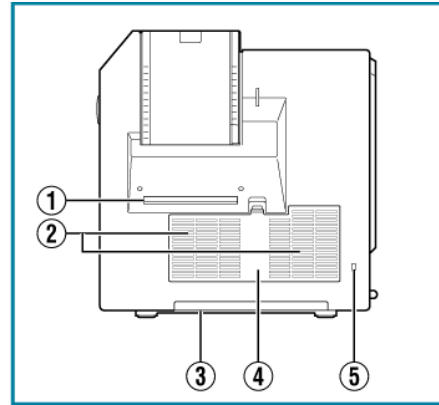

- ① NG card outlet
 - If a card is left inside the printer when the power is turned on or reset, the card will be automatically discharged.
 - Cards in the printer are discharged when an error occurs in the magnetic stripe card or IC card.
- ② Air suction fan opening
 - Air inlet of the internal cooling fan.
- ③ Handle
 - Hold this area when moving the printer.
- ④ Filter cover
 - Cover of the fan filter.
- ⑤ Security slot
 - An anti-theft device that supports Kensington locks can be installed.

Rear

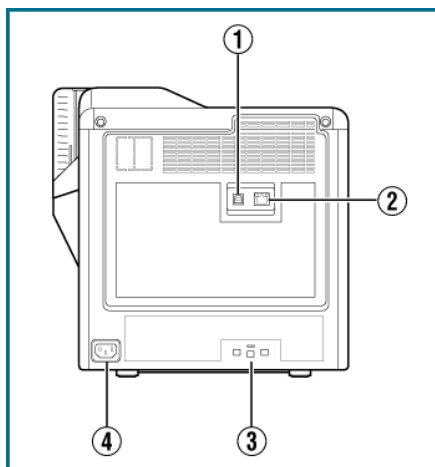

- ① USB cable connection terminal
 - For connecting a USB 2.0 interface cable.
- ② LAN cable connection terminal
 - For connecting a LAN cable.
- ③ Cable clamp
 - For securing the supplied USB cable.
- "Connection" (see page 64)
- ④ AC inlet
 - For connecting the power cord.

Left

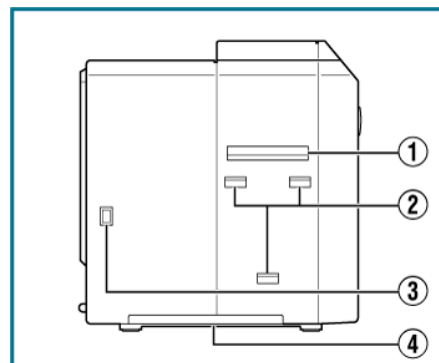

- ① Card outlet
 - Outlet for discharging the cards.
- ② Card stacker (supplied) attachment slot
 - For installing the supplied card stacker.
- ③ Infrared window
 - Sends or receives data via infrared communication by connecting with an external unit.
- ④ Handle
 - Hold this area when moving the printer.

When Printer Door is Open

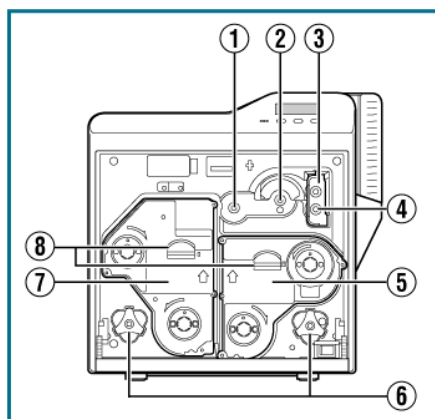

- ① Card feed roller shaft
 - When a card jam occurs, attach a jog dial to turn the card feed roller.
- ② Card turn over unit shaft
 - When a card jam occurs, attach a jog dial to turn the card turn over unit.
- ③ Cleaning unit
 - Removes dust or dirt attached to the card.
- ④ Cleaning roller shaft
 - When a card jam occurs, attach a jog dial to turn the cleaning roller.
- ⑤ Ink ribbon cassette
 - For installing the ink ribbon.
- ⑥ Jog dials
 - For removing jammed cards by turning it after it is detached from the printer unit and attached to the shaft.
- ⑦ Retransfer film cassette
 - For installing the retransfer film.
- ⑧ Cassette buttons
 - Press these buttons in order to pull out the ink ribbon cassette or retransfer film cassette.

Retransfer Film Cassette

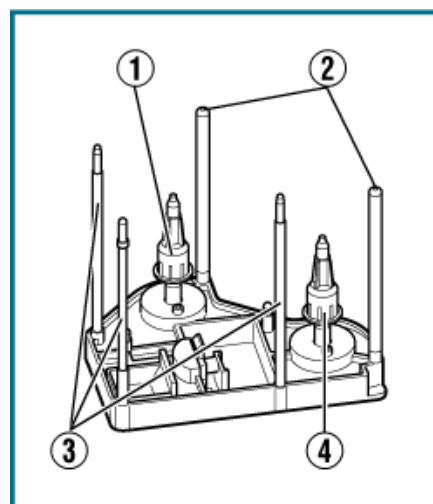

- ① Bobbin holder (black)
 - For securing the take-up side of the retransfer film.
- ② Guide shaft
 - Provides guide to the position for installing the cassette.
- ③ Shafts
 - For installing the retransfer film.
- ④ Bobbin holder (green)
 - For securing the unused side of the retransfer film.

Ink Ribbon Cassette

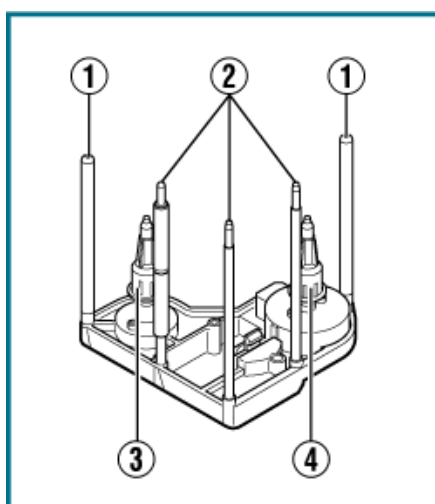

- ① Guide shaft
 - Provides guide to the position for installing the cassette.
- ② Shafts
 - For installing the ink ribbon.
- ③ Bobbin holder (black)
 - For securing the take-up side of the ink ribbon.
- ④ Bobbin holder (yellow)
 - For securing the unused side of the ink ribbon.

Specifications

Main Specifications

Item	Description
Recording system	Dye sublimation retransfer
Paper feed mode	Automatic
Recording density	300 dpi
Reproduction gradation	256 levels each for Y, M and C 2 levels for Resin K
Interface	USB2.0(Hi-speed/Full Speed) Ethernet(100BASE-TX/10BASE-T)
Operating environment conditions	Temperature: 15 °C to 30 °C (When peel-off ink, UV ink is used: 17 °C to 28 °C) Humidity: 35 % to 70 % No condensation (When peel-off ink, UV ink is used: 35 % to 60 %)
Storage environment conditions	<Printer unit> Temperature: -15 °C to 55 °C Humidity: 20 % to 80 % <Printing media (retansfer film or ink ribbon) / card> Temperature: 5 °C to 25 °C Humidity: 40 % to 60 %
Power supply	AC 100 V - 120 V, 50 Hz/60 Hz AC 220 V - 240 V, 50 Hz/60 Hz
Current consumption	3.5 A (100 V system) 1.6 A (200 V system)
Power consumption	310 W (maximum power when all options are installed)
Mass	approx. 13.5 kg (single-sided printer, including bend remedy unit)
Dimensions	343 mm x 335 mm x 322 mm (W x H x D)

Outline Dimensional Drawing

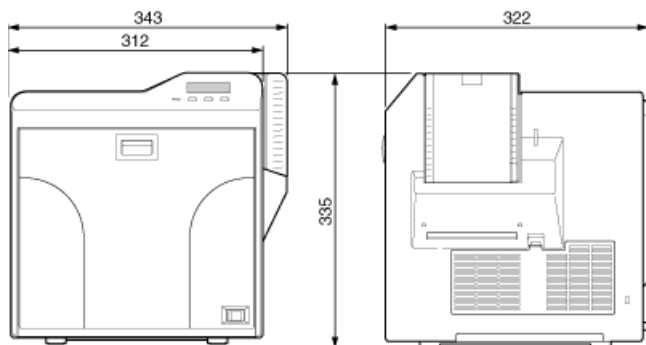

*The specifications and appearance of this product may be modified for improvement without prior notice.

Accessories/Products Sold Separately

Accessories

Please check to ensure that the printer accessories are in place when unpacking the product package.

- CD-ROM x 1
- Instruction Manual x 1
- "READ ME FIRST"(LST1004) x 1
- Power Cord (2 m) x 2
- Cleaning Card x 1
- Card Stacker x 1
- USB 2.0 Cable (2 m) x 1
- Gloves x 1
- Tweezers x 1

Products Sold Separately

To purchase these items, please consult our authorized dealers. Use the retransfer film or ink ribbon within one year after purchase.

- YMCK (1000 frames/roll) Set, Model: CY-P340A-DN
- YMCKP (750 frames/roll) Set, Model: CY-P35PA-DN
- Ink Ribbon (YMCKK) 750 frames/roll, Model: CY-35K-75D
- Ink Ribbon (YMCKU) 750 frames/roll, Model: CY-35U-75D
- Retransfer Film 1000 frames/roll, Model: CY-3RA-100
- Cleaning Kit, Model: CX210-CKIT1
Magnetic Head Cleaning Card (5 Pcs), Cotton Swab (5 Large and 5 Small), Cleaning Wipes (1 Box)
- Cleaning Card, Model: CX210-CC1
10 Pcs/Set

Options

Options

- Bend remedy unit
Device for correcting card bend after printing.
- Magnetic encoder
Device for writing data to a magnetic stripe card.
It can only be installed on a double-sided printer.
- Contact IC encoder
Device for writing data to a contact IC card.
- Non-contact IC encoder
Device for writing data to a non-contact IC card.

Printing a Card

Cautions:

- If you see an [Initializing..] or [Preheating..] message on the LCD panel of the printer, this means the printer is not ready yet. Printing cannot be performed until a [Ready] message appears.
- Printing the card on the side with the magnetic stripe may cause printing errors or damage to the card's functions. If you want to do so, please consult our authorized dealers in advance.
- For printing using application software prepared by the user, refer to the instruction manual of the corresponding application.

1 Turn on the power

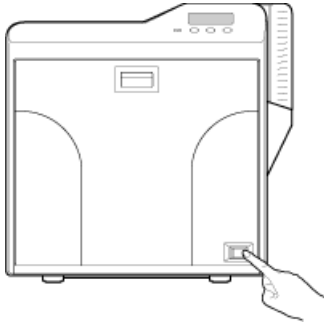

2 Check to ensure that cards are inserted into the card hopper

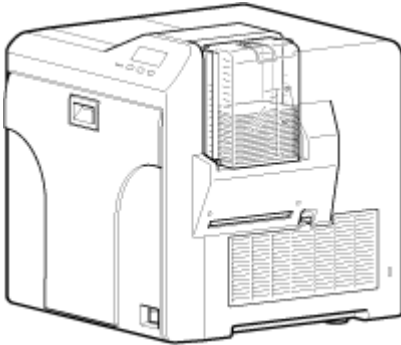

3 Open the application's print settings screen, and select this printer in [Name]

- If there are multiple printers, select the name of the printer that you want to perform printing on.

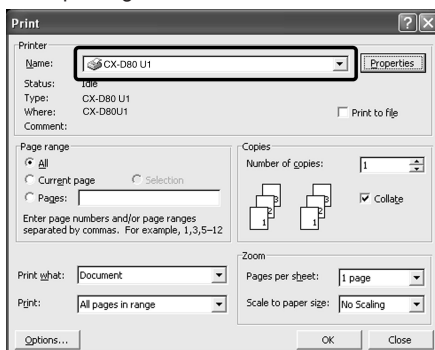

4 After ensuring that a [Ready] message appears on the LCD panel of the printer, start printing

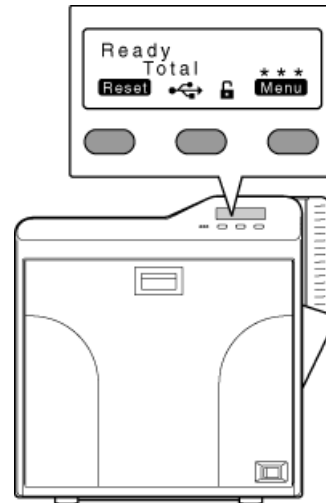

Operation Panel

Name and Functions of Parts

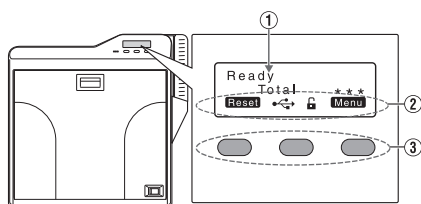

- ① Operation panel
 - Displays the settings, operating status, and error messages.
- ② Status icon/operation button display
 - Displays the status icon and function of the operation button.
- ③ Operation buttons
 - For selecting a button function displayed on the operation panel.

Operation Buttons

■ Resets the printer.

Reset

- Press **Reset** →  in sequence.

■ Enters the setting mode.

Menu

- Exits setting.
Pressing it each time brings you to the setting item on the next higher level.

Exit

■ Displays the setting item on the next lower level.

Enter

■ Confirms or executes the setting.



■ Pressing it each time displays the next setting item.

Next

■ Pressing it each time displays the next setting.



■ Enters the settings change mode.

Change

- If **Change** is not displayed for an item, you can adjust the settings on the status monitor of a computer.

"Status Monitor Settings" (page 111)

■ Enters the scroll mode for the displayed characters.

Scroll

■ Scrolls to the next displayed character on the left.



■ Scrolls to the next displayed character on the right.



Icon Displays on the Operation Panel

■ USB connection

- IP address established

Printer information can be viewed through the network. However, printing is performed through USB connection.



- IP address not established



■ Network connection

- IP address established



- IP address not established



■ Security lock status

- Locked



- Unlocked



Operation Panel Operation Display

Background color

Changes according to the printer's operating status.

- During startup

Bright green

- Under normal circumstances

Sky blue

- During initialization using **Reset**, during test printing using the operation panel, cleaning, downloading and during security lock setting using the operation panel

Light purple

- During error

Red

■ Starting up

Boot Up..

■ Initializing

Initializing..

■ Preheating

Preheating..

■ Ready

Ready

■ Feeding card or discharging NG card

Moving..

■ Printing

Printing..

■ Test print in progress

Testing..

■ Loading card

Loading..

■ Downloading

Downloading..

■ Magnetic encoding in progress

MG Encoding..

■ IC encoding

IC Encoding..

■ Adjusting heating roller to the preset temperature

Heating..

■ Retransferring

Retransfer..

■ Cleaning

Cleaning..

■ Power Saving mode

Sleeping..

Setting Mode

- Settings can be viewed on the printer's operation panel.
- Settings can be changed on the status monitor of the computer.

"Setting Using the Operation Panel" (☞ page 22)

"Sequence of Setting Modes" (☞ page 17)

"Factory Settings" (☞ page 19)

Cleaning

- For setting during cleaning of the card feed roller, heating roller or magnetic head.

"Card Feed Roller/Heating Roller" (☞ page 37)

"Magnetic Head" (☞ page 39)

Settings

- Rollers

Select this value when cleaning the card feed roller or heating roller.

- MG

Select this value when cleaning the magnetic head.

Counter Reset

- This is used to reset the free counter and error counter.

"Counter Reset" (☞ page 26)

Test Print

- Prints the printer's built-in test pattern, or the different settings.

"Test Print" (☞ page 23)

Settings

- Test Print: Test Pattern, Printer Setting, Network Setting, Lami Setting

Download

- Updates the firmware.

"Firmware Update" (☞ page 24)

Transport Mode

- For setting the transport mode.

"Transport Mode Setting" (☞ page 29)

Media

- Displays the settings of the printing media.

Settings

- Ink Type: YMCK, YMCKPO, YMCKK, YMCKUV

Displays the ink ribbon type.

- Film Type: 1000, 750

Set according to the type of retransfer film.

- Card Thickness: Standard, Thin

Set according to the thickness of the card.

Standard: Supports card thickness of 0.76 mm

Thin: Supports card thickness of 0.25 mm

Print

- Displays the printing settings.

Settings

- YMC Level: -3, -2, -1, 0, 1, 2, 3

For setting the YMC (color) density level.

Selecting a larger value increases the density level.

- Black Level: -3, -2, -1, 0, 1, 2, 3

For setting the K (black) density level.

Selecting a larger value increases the density level.

- Black Mode: Standard, Fine

For setting the printing mode for the K (black) component.

If the characters still appear faded after raising the [Black Level], set to [Fine]. However, printing time required will be longer than the [Standard] setting.

- UV Level: -3, -2, -1, 0, 1, 2, 3

For setting the UV ink density level.

Selecting a larger value increases the density level.

During UV printing, card bend may increase if the card has a low heat resistance or in an environment with high temperature.

- PO Level: -3, -2, -1, 0, 1, 2, 3

For setting the density level of the peel-off ink.

Selecting a larger value increases the density level.

Retransfer

- Displays the retransfer mode settings.

Settings

- Temp Level: -2, -1, 0, 1, 2

For setting the retransfer heating roller temperature.

Selecting a larger value increases the temperature.

Retransfer may fail depending on the card used. If retransfer fails, raise the setting to the next higher value.

A higher retransfer heating roller temperature helps to enhance the card retransfer performance, but the stronger heat may cause the card to deform more.

If the printer is not reset after changing the temperature setting, temperature is adjusted after the printing operation starts.

- Speed (Front): -3, -2, -1, 0, 1, 2

For setting the front side retransfer speed.

Selecting a larger value increases the speed.

Retransfer may not be successful on some parts of the card depending on the card used. Lowering the setting value helps to enhance the retransfer performance, but the stronger heat may cause the card to deform more.

- Speed (F-UV): -3, -2, -1, 0, 1, 2

For setting the retransfer speed of the second panel on the front side during UV ink printing of retransfer films in two panels. Selecting a larger value increases the speed.

- Speed (Back): -3, -2, -1, 0, 1, 2

For setting the back side retransfer speed.

Selecting a larger value increases the speed.

Some types of cards may bend during double-sided printing. If card bend occurs, raise the back side retransfer speed to one level higher than the front side retransfer speed setting.

- Speed (B-UV): -3, -2, -1, 0, 1, 2

For setting the retransfer speed of the second panel on the back side during UV ink printing of retransfer films in two panels. Selecting a larger value increases the speed.

- MG Peel Mode: Standard, MG Stripe

For setting the method for peeling the retransfer film.

Retransfer at areas close to the magnetic stripe may not be performed correctly for some card types. When a magnetic stripe card is used, this problem may be remedied by setting to [MG Stripe].

- Standby Mode: Front wait, Back wait

During double-sided printing by connecting to a laminator, retransfer remains in the standby state until the laminator is in the [Ready] mode.

Select whether to standby using the front or back side.

- Backside Cool: On, Off

For setting the time interval for cooling the card before performing retransfer on the back side during double-sided printing. Setting this to [On] may help to reduce card bend.

Bend Remedy

- Displays the bend remedy mode settings.

Settings

- Temp Level: -5, -4, -3, -2, -1, 0, Off

For setting the bend remedy heating roller temperature.

Selecting a larger value increases the temperature.

If the printer is not reset after changing the temperature setting, temperature is adjusted after the printing operation starts.

- Speed: -2, -1, 0, 1, 2

For setting the bend remedy speed.

Selecting a larger value increases the speed.

Heat Roller

- Displays the settings of the Power Saving mode or HR Control mode.

Settings

- Power Saving: 5, 10, 15, 20, 25, 30, 45, 60, Off (unit: minutes)

For setting the time for the Power Saving mode.

While in the [Ready] mode, if the printer is not operated for a specific time interval, the retransfer heating roller, bend remedy heating roller, and backlight of the operation panel will turn off automatically to save power.

While in the Power Saving mode, [Sleeping..] is displayed.

To cancel the setting temporarily using the operation panel, press

Reset →  to reset the printer.

- HR Control: Off, On

For setting whether to standby the printer by lowering the retransfer heating roller temperature if cards are not printed for 30 minutes or longer.

The printer will automatically be restored to the original mode during the next card printing, but it may take a longer time before the first card is printed. Set this to [On] during normal use.

Setting

- Displays the printer settings.
- Setting can also be performed using the printer's operation panel.

Settings

- Display:

Mode: Counter, Laminator State

This is used for setting the information to be displayed on the operation panel.

"Display Mode Setting" (☞ page 25)

Counter: Total Cnt, Head Cnt, Free Cnt, Cleaning Cnt, Error Cnt

This is used for setting the type of counter displayed on the operation panel.

"Counter Setting" (☞ page 25)

Contrast: -3, -2, -1, 0, 1, 2, 3

For setting the contrast of the operation panel display.

"Contrast Setting" (☞ page 27)

- Buzzer: On, Off

For setting whether to sound the buzzer when an error occurs or when settings are changed.

"Buzzer Setting" (☞ page 28)

- Unit No.: No.1 - No.10

For setting the printer's unit number according to the USB environment.

"Unit Number Setting" (☞ page 28)

Option

- Displays the optional settings.

Settings

- MG: None, ISO

Displays the availability of a magnetic encoder or the type of magnetic encoder used.

- IC Antenna: None, Installed

Displays the availability of a non-contact IC encoder.

- IC Contact: None, ISO Type

Displays the availability of a contact IC encoder (contact section) or the type of IC encoder used.

- Contact IC R/W: None, Installed

Displays the availability of a contact IC R/W.

- Bend Remedy HR: None, Installed

Displays the availability of a bend remedy unit.

- Turn Over: None, Installed

Displays the availability of a card turn over unit.

MG

- Displays the magnetic encoder settings.

Settings

- ISO Type: Loco, Hico

For setting the coercivity when writing data to an ISO magnetic stripe card.

- Retry Count: 0, 1, 2, 3

For setting the maximum number of retries when writing to or reading of the magnetic stripe fails.

Network

- Displays the network settings.

Settings

- Printer Name: ASCII character strings (10 characters)

For setting the printer name.

- Host IF: LAN, USB

For setting the interface.

If the printer is connected via USB interface, the setting switches automatically to USB when initialization starts even if the LAN setting is selected.

- IPv4:

DHCP: On, Off

Setting: IP Address, Subnet Mask, Gateway

Effective IP: IP Address

For setting IPv4.

- IPv6:

Adrs Config: Auto, Manual

Setting: IP Address, Prefix Len, Gateway

Effective IP: IP Address1, IP Address2, IP Address3

For setting IPv6.

- Session Time Out: Off, 10 min, 20 min, 30 min, 60 min

For setting the session timeout interval.

- MAC Address: Hexadecimal character strings

Displays the MAC address.

- IPsec Mode: Off, On

For setting the availability of IPsec.

- IPsec Type: not Setting, Preshard, Certificate

Displays the method of IPsec authentication.

Sequence of Setting Modes

- Settings can be viewed on the printer's operation panel.
 - Settings can be changed on the status monitor of the computer.
- "Setting mode" (page 15)

1 Press **Menu**

- Enters the setting mode.

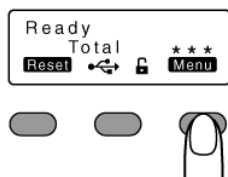

2 Press **Next**

- Pressing it each time displays the next setting item.
- Pressing **Enter** displays the setting item on the next lower level.
- Pressing **Change** enters the settings change mode.
- Pressing **←** confirms or executes the setting.
- Pressing **Exit** displays the setting item on the next higher level.

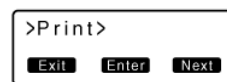
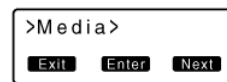
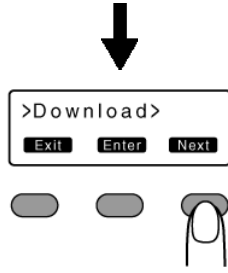
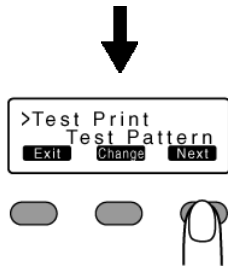
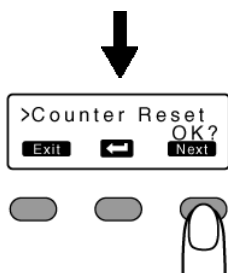
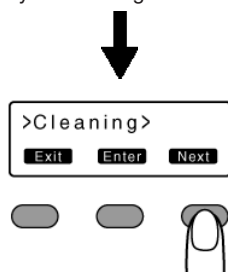

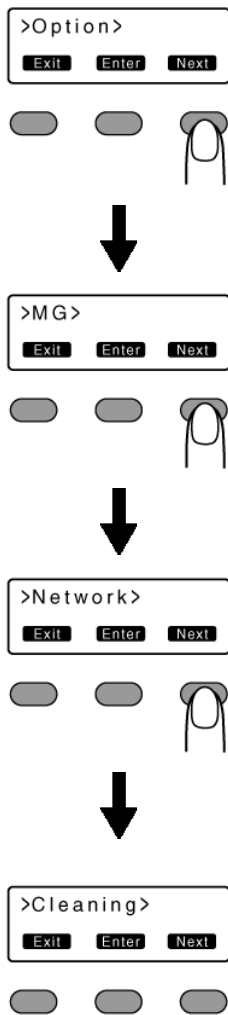

Factory Settings

■ **Media**

Item	Factory Settings
Ink Type	-
Film Type	1000
Card Thickness	Standard

■ **Print**

Item	Factory Settings
YMC Level	0
Black Level	0
Black Mode	Standard
UV Level	3
PO Level	0

■ **Retransfer**

Item	Factory Settings
Temp Level	1
Speed (Front)	2
Speed (F-UV)	2
Speed (Back)	2
Speed (B-UV)	2
MG Peel Mode	Standard
Standby Mode	Front Wait
Backside Cool	Off

■ **Bend Remedy**

Item	Factory Settings
Temp Level	Off
Speed	2

■ **Heat Roller**

Item	Factory Settings
Power Saving	Off
HR Control	On

■ **Setting**

Item	Factory Settings	
Display	Mode	Counter
	Counter	Total Cnt
	Contrast	0
Buzzer	On	
Unit No.	No.1	

■ **MG**

Item	Factory Settings
ISO Type	Hico
Retry Count	1

■ **Network**

Item		Factory Settings	
Printer Name		PRINTER01	
Host IF		LAN	
IPv4	DHCP		On
	Setting	IP Address	192.168.0.141
		Subnet Mask	255.255.255.0
		Gateway	192.168.0.1
	Effective IP	IP Address	-
IPv6	Adrs Config		Auto
	Setting	IP Address	None
		Prefix Len	64
		Gateway	None
	Effective IP	IP Address 1	-
		IP Address 2	-
		IP Address 3	-
Session Time Out		Off	
Mac Address		-	
IPSec Mode		Off	
IPSec Type		not Setting	

Security Lock

- The security lock function can be applied to the printer door and card hopper to prevent opening of the printer door as well as removal of cards.
- The lock can be turned on/off using the status monitor on the computer.

"Status monitor" (see page 121)

- By registering a security key number on the printer unit, you can turn off the security lock by entering the security key number on the operation panel of the printer.
- If you forgot the security key number, please consult our authorized dealer or the servicing personnel.

Registration of Security Key Number

- To change the security key number, you have to delete it and register a new number again.

1 Press the operation button (center) for at least three seconds

- A [Set Sec-Key OK?] message appears.

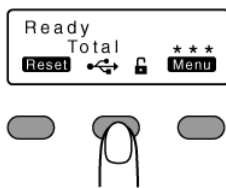

2 Press

- A [New key] message appears.

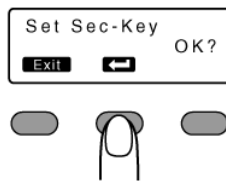

3 Enter a number

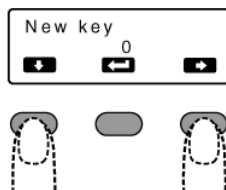

- You can enter up to 8 digits.
- Pressing each time advances to the next number.
- Pressing each time advances to the next digit.

4 Press

- A [Re-enter] message appears.

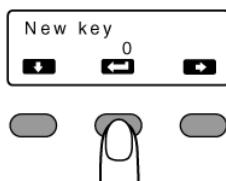

5 Input the number you have entered in [New key] again

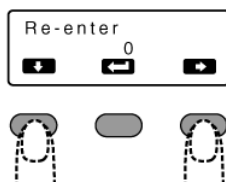

6 Press

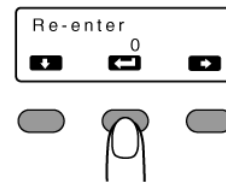

- If this number is consistent with the number entered in [New key], the display returns to [Ready], and the security key number is registered.
- If this number is not consistent with the number entered in [New key], the display returns to [Set Sec-Key OK?]. Enter a number again.

Deactivating the Security Lock

- When a security lock is turned on, you can deactivate it as follows.

1 Press the operation button (center) for at least three seconds

- A [Unlock Sec-Key OK?] message appears.

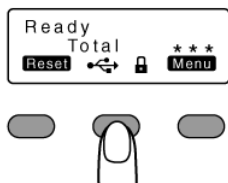

2 Press **←**

- A [Key for unlock] message appears.

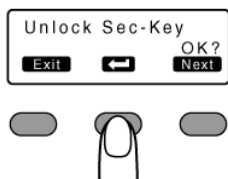

3 Enter the registered security key number

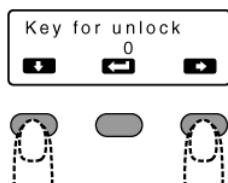

- Pressing **↓** each time advances to the next number.
- Pressing **→** each time advances to the next digit.

4 Press **←**

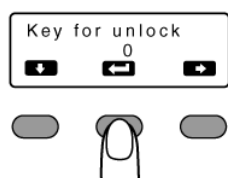

- If this number is consistent with the registered number, the display returns to [Ready], and the security lock is deactivated.
- If this number is not consistent with the registered number, the display returns to [Unlock Sec-Key OK?]. Enter a number again.

Deleting the Security Key Number

- You can delete a registered security key number as follows.
- To change the security key number, you have to delete it and register a new number again.

1 Press the operation button (center) for at least three seconds

- A [Unlock Sec-Key OK?] message appears.

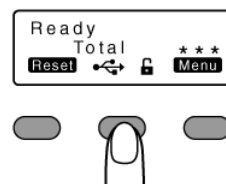

2 Press **Next** to set to [Delete Sec-Key OK?]

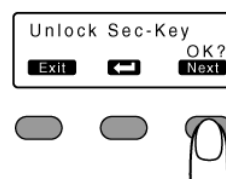

3 Press **←**

- A [Key for DEL] message appears.

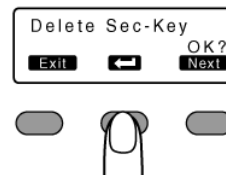

4 Enter the registered security key number

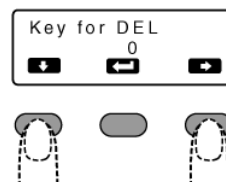

- Pressing **↓** each time advances to the next number.
- Pressing **→** each time advances to the next digit.

5 Press **←**

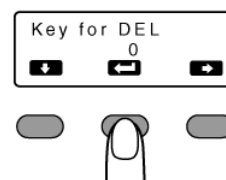

- If this number is consistent with the registered number, the display returns to [Ready], and the security key number is deleted.
- If this number is not consistent with the registered number, the display returns to [Delete Sec-Key OK?]. Enter a number again.

Setting Using the Operation Panel

Initialization

- Whenever the power is turned on, cue (initialization) is performed automatically on the ink ribbon and retransfer film.
- You can also perform initialization manually using the operation button on the operation panel.

1 Press **Reset**

- An [Initialize OK?] message appears.

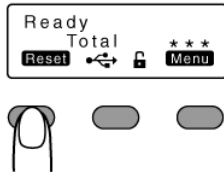

2 Press **↵**

- An [Initializing..] message appears, and initialization of the printer starts.

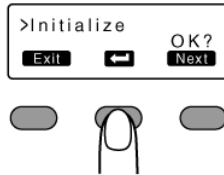

Initializing Printer When Installing the Cassette

Memo:

- When detaching the ink ribbon cassette or retransfer film cassette from the printer body, dust may adhere to the ink ribbon or retransfer film. Errors such as discoloring may occur depending on the size of the dust particles. To avoid these problems, it is recommended that you forward by one or two images after installing the cassette.

1 Press **Reset**

- An [Initialize OK?] message appears.

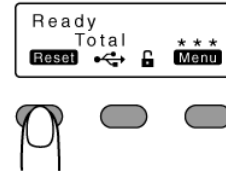

■ Initializing printer without feeding the image

① Press **↵**

- An [Initializing..] message appears, and initialization of the printer starts.

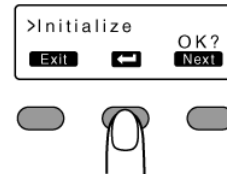

■ Initializing printer after feeding by one image

① Press **Next** to set to [Next Panel, OK?]

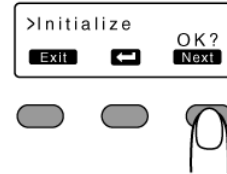

② Press **↵**

- An [Initializing..] message appears, and the printer is initialized after feeding the ink ribbon and retransfer film by one image.

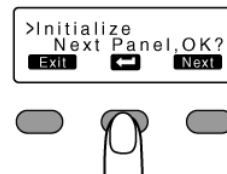

■ Initializing printer after feeding by two images

- ① Press **Next** to set to [2'nd Panel, OK?]

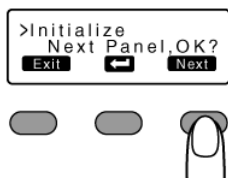

- ② Press **Left Arrow**

- An [Initializing..] message appears, and the printer is initialized after feeding the ink ribbon and retransfer film by two images.

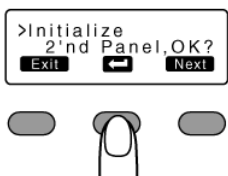

Test Print

- Prints the printer's built-in test pattern, or the different settings.
- The printer unit can be made to run alone when a system error occurs by separating the computer from the printer.

Test Pattern Types

- Test Pattern: Prints standard color pattern on a single side of a card.
- Printer Setting: Prints the printer settings.
- Network Setting: Prints the network settings.
- Lami Setting: Prints the laminator settings.

- 1 Press **Menu**

- A [Cleaning] message appears.

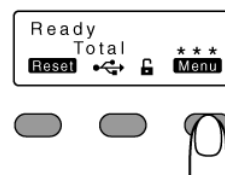

- 2 Press **Next** to set to [Test Print]

- Pressing it each time displays the next setting item.

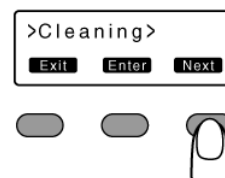

- 3 Press **Change**

- A test pattern selection screen appears.

- 4 Press **Down Arrow** and select a test pattern type

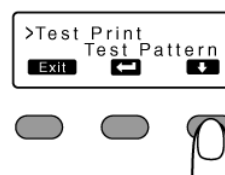

- 5 Press **Left Arrow**

- Test print starts.

Firmware Update

1 Press **Menu**

- A [Cleaning] message appears.

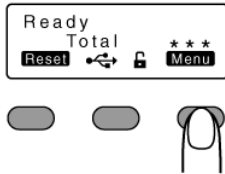

2 Press **Next** to set to [Download]

- Pressing it each time displays the next setting item.

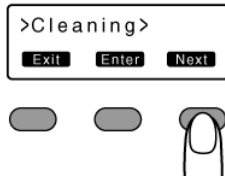

3 Press **Enter**

- A [Download Ready] message appears, indicating that the printer is ready to download data from the computer.

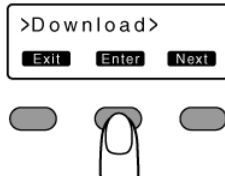

4 Start data download from the computer

- A [Downloading..] message appears.



Cautions:

- Do not turn off the power during data download from the computer. Doing so may damage the printer firmware and cause malfunction.
- A [Download Ready] message appears when data download from the computer is complete.



5 When [Download Ready] appears, press **Exit**

6 When the [Please Power Off] message appears, turn off the power

- The firmware is updated after the power is turned on again.

■ If download fails and printer cannot be started up

- If download of the printer firmware fails, the printer may not be able to start up when it is rebooted. When this occurs, download the firmware again according to the following procedure.

① Turn on the power while holding down the operation button (center)

- A [SBP2 Running] message appears, indicating that the printer is ready to download data from the computer.

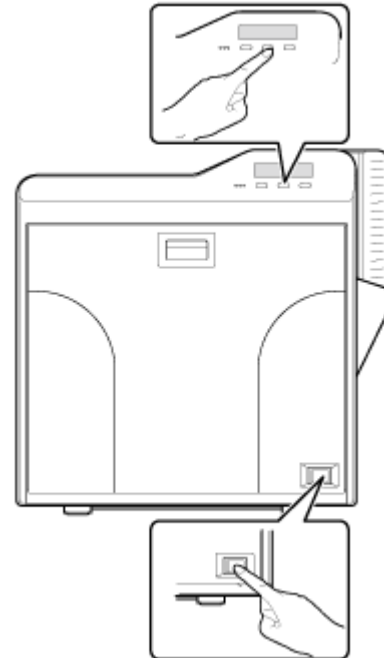

② Start data download from the computer

- A [Downloading..] message appears.
 - A [SBP2 Running] message appears when data download from the computer is complete.
- ③ When the [SBP2 Running] message appears, turn off the power
- The firmware is updated after the power is turned on again.

Display Mode Setting

- This is used for setting the information to be displayed on the operation panel.

Settings

- Counter:**
Displays the counter preset in "Counter setting".
- Laminator State:**
Displays the operating status of the connected laminator. If a laminator is not connected, the counter is displayed.

1 Press **Menu**

- A [Cleaning] message appears.

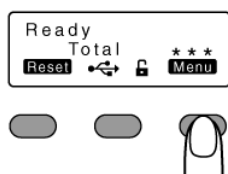

2 Press **Next** to set to [Setting]

- Pressing it each time displays the next setting item.

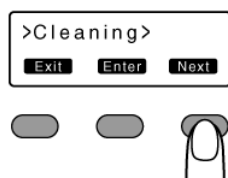

3 Press **Enter**

- A [Display] message appears.

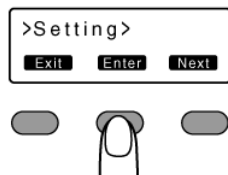

4 Press **Enter**

- A [Mode] message appears.

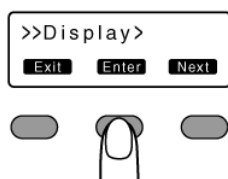

5 Press **Change**

- Enters the settings change mode.

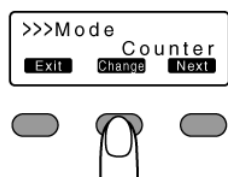

6 Press **Down Arrow** and select a setting

7 Press **Left Arrow** to confirm the setting

- Pressing **Right Arrow** confirms the setting and returns you to the previous screen.

8 Press **Exit** to exit the setting mode

- Pressing it each time displays the setting item on the next higher level.

Counter Setting

- This is used for setting the type of counter displayed on the operation panel.

Counter Types

- Total Cnt: total counter**
Displays the total number of cards that are correctly printed.
- Head Cnt: head counter**
Displays the total number of printed sides for the same head.
- Free Cnt: free counter**
Displays the number of cards that are correctly printed. This number can be reset.
- Cleaning Cnt: cleaning counter**
Displays the number of cards that are correctly printed after the last cleaning.
- Error Cnt: error counter**
Displays the number of cards that are not correctly printed. This number can be reset.

1 Press **Menu**

- A [Cleaning] message appears.

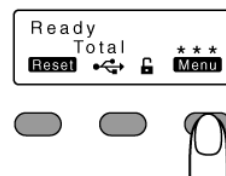

2 Press **Next** to set to [Setting]

- Pressing it each time displays the next setting item.

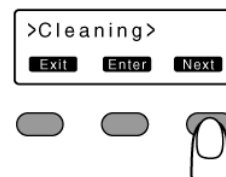

3 Press **Enter**

- A [Display] message appears.

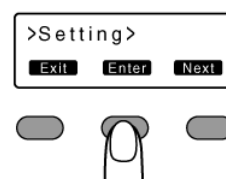

4 Press **Enter**

- A [Mode] message appears.

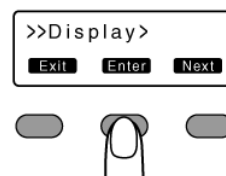

5 Press **Next** to set to [Counter]

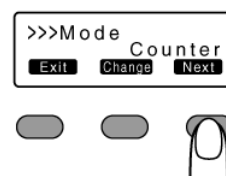

Operating the Printer

6 Press **Change**

- Enters the settings change mode.

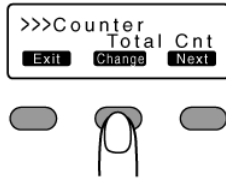

7 Press **↓** and select a setting

8 Press **↵** to confirm the setting

- Pressing **↵** confirms the setting and returns you to the previous screen.

9 Press **Exit** to exit the setting mode

- Pressing it each time displays the setting item on the next higher level.

Counter Reset

- This is used to reset the free counter and error counter.

1 Press **Menu**

- A [Cleaning] message appears.

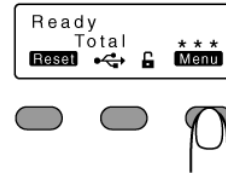

2 Press **Next** to set to [Counter Reset]

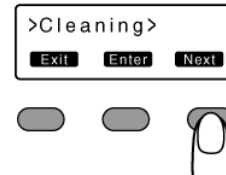

3 Press **↵**

- Resets the free counter and error counter.

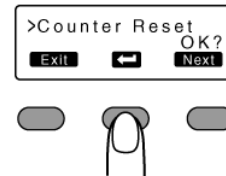

■ Checking reset

- Select [Free Cnt] or [Error Cnt] for "Counter setting".

Contrast Setting

- For setting the contrast of the operation panel display.

Settings

- 3, -2, -1, 0, 1, 2, 3

Selecting a larger value increases the contrast.

1 Press **Menu**

- A [Cleaning] message appears.

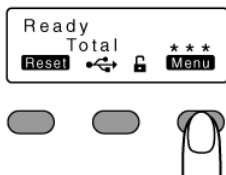

2 Press **Next** to set to [Setting]

- Pressing it each time displays the next setting item.

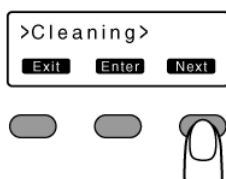

3 Press **Enter**

- A [Display] message appears.

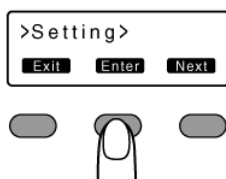

4 Press **Enter**

- A [Mode] message appears.

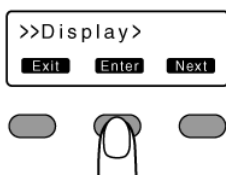

5 Press **Next** to set to [Contrast]

- Pressing it each time displays the next setting item.

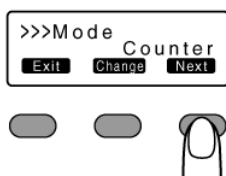

6 Press **Change**

- Enters the settings change mode.

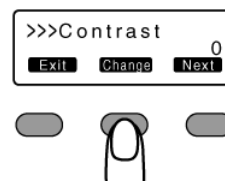

7 Press **↓** and select a setting

8 Press **←** to confirm the setting

- Pressing **←** confirms the setting and returns you to the previous screen.

9 Press **Exit** to exit the setting mode

- Pressing it each time displays the setting item on the next higher level.

Buzzer Setting

- For setting whether to sound the buzzer when an error occurs or when settings are changed.

Settings

- On: turns on buzzer sound, Off: turns off buzzer sound

1 Press **Menu**

- A [Cleaning] message appears.

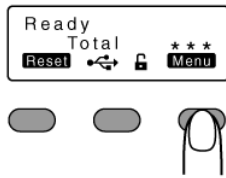

2 Press **Next** to set to [Setting]

- Pressing it each time displays the next setting item.

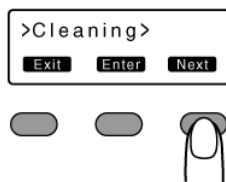

3 Press **Enter**

- A [Display] message appears.

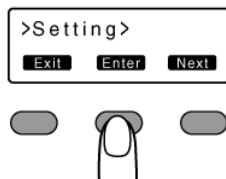

4 Press **Next** to set to [Buzzer]

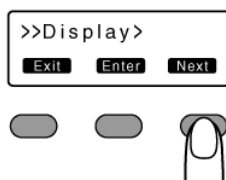

5 Press **Change**

- Enters the settings change mode.

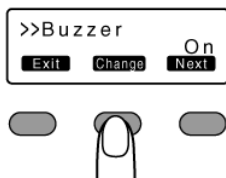

6 Press **Down Arrow** and select a setting

7 Press **Left Arrow** to confirm the setting

- Pressing **Left Arrow** confirms the setting and returns you to the previous screen.

8 Press **Exit** to exit the setting mode

- Pressing it each time displays the setting item on the next higher level.

Unit Number Setting

- For setting the printer's unit number according to the USB environment.

Settings

- No.1 - No.10

1 Press **Menu**

- A [Cleaning] message appears.

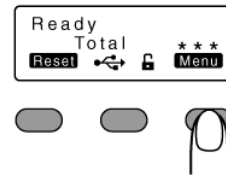

2 Press **Next** to set to [Setting]

- Pressing it each time displays the next setting item.

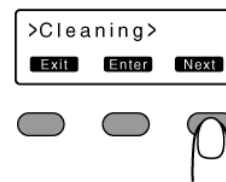

3 Press **Enter**

- A [Display] message appears.

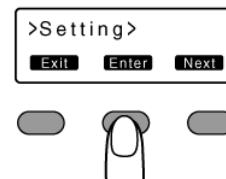

4 Press **Next** to set to [Unit No.]

- Pressing it each time displays the next setting item.

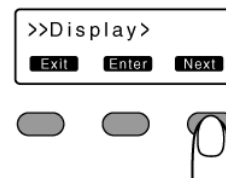

5 Press **Change**

- Enters the settings change mode.

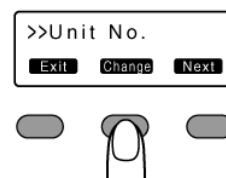

6 Press **Down Arrow** and select a setting

- You can select the unit number from No. 1 to No. 10.

7 Press **Left Arrow** to confirm the setting

- Pressing **Left Arrow** confirms the setting and returns you to the previous screen.

8 Press **Exit** to exit the setting mode

- Pressing it each time displays the setting item on the next higher level.

9 Turn off the power

- The changes to the setting will be reflected when you turn on the power again.

Transport Mode Setting

- When transporting or moving the printer, ensure that the heating roller is fastened to a safe position.

Cautions:

- Make sure that you set to the transport mode when transporting or moving the printer. Failure to do so will cause the printer to malfunction.

1 Open the printer door



2 Press and hold down the cassette button, and remove the ink ribbon cassette (on the right) to remove the ink ribbon

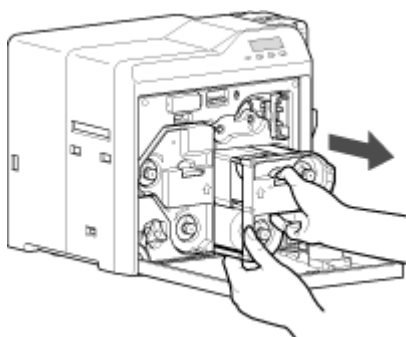

3 Press and hold down the cassette button, and remove the retransfer film cassette (on the left) to remove the retransfer film

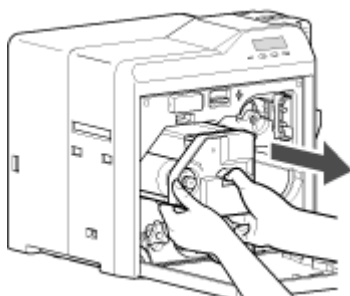

4 Close the printer door

5 Press **Reset** → **←** to reset the printer

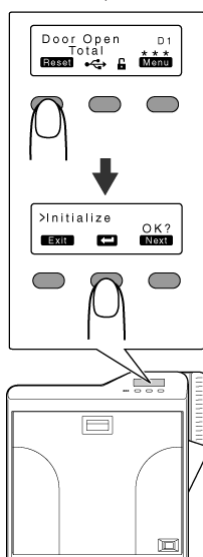

6 Check to ensure that [Film Search] is displayed on the operation panel of the printer

7 Press **Menu**

- A [Cleaning] message appears.

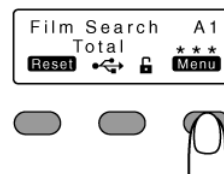

8 Press **Next** to set to [Transport Mode]

- Pressing it each time displays the next setting item.

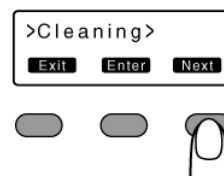

9 Press **←**

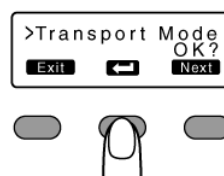

- After setting to the transport mode, a [Please Power Off] message appears.

10 Turn off the power, and install the cassette

Cautions:

- While in the transport mode, the retransfer film cassette cannot be installed to the printer with the retransfer film loaded.

■ Canceling the transport mode

- With the printer door closed, turn on the power to cancel the transport mode.

Setting Using the Status Monitor

"Status Monitor Settings" (☞ page 111)

Cards

Cards have Run Out

- Replenish the cards.
- The card hopper is able to store up to about 100 cards with a thickness of 0.76 mm.

Cautions:

- Get ready cards that are designated by the authorized dealer.
- If the security lock is on, deactivate it. After work is complete, activate the security lock again.
- Do not touch the printing surface of the card. Touching it may cause printing errors. Put on the supplied gloves when handling the cards.
- To prevent card jams from occurring, limit the number of cards stored in the card hopper at any time to about 100 pieces regardless of the card thickness.
- When using new cards, set them after making sure that they are not adhered to each other due to static.
- Align the cards before setting them in the printer. Otherwise, the card hopper cover may not close properly, and this may damage the printer.
- Printing the card on the side with the magnetic stripe may cause printing errors or damage to the card's functions. If you want to do so, please consult our authorized dealers in advance.
- To set cards with both functions (magnetic stripe and contact IC), follow the procedure for setting the contact IC card.

1 Set the card hopper knob to [OPEN]

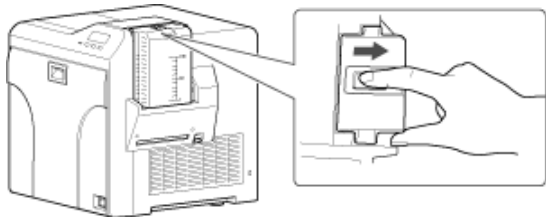

2 Lift to remove the card hopper cover

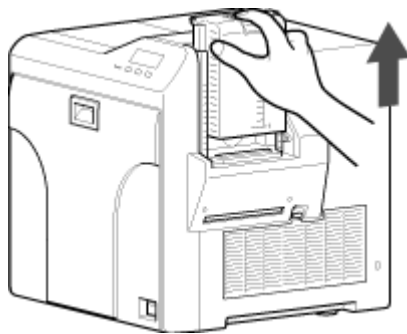

3 Align the orientation of the cards, and set them in the printer

■ Magnetic stripe cards

- Set the card with the magnetic stripe facing upward and toward the printer, or facing downward and toward you.

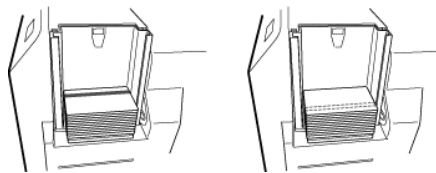

■ ISO contact IC cards

- Set the card with the Contact IC terminal facing upward and toward the rear of the printer, or downward and toward the rear of the printer.
- For single-sided printers, set the cards with the IC terminal facing down and toward the rear of the printer.

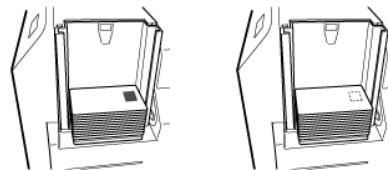

4 Install the card hopper cover, and set the card hopper knob to [LOCK]

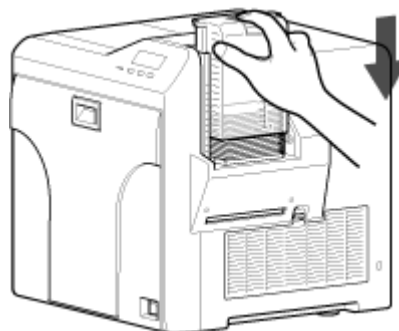

Ink Ribbon

Ink Ribbon has Run Out

- Replace with a new ink ribbon.

Cautions:

- If the security lock is on, deactivate it. After work is complete, activate the security lock again.
- Stand the cassette on a flat surface as illustrated in the diagram. Avoid doing so on the floor as dust attached to it may cause printing errors.

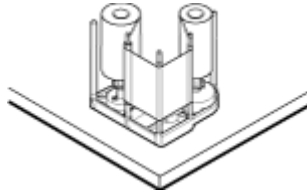

- Do not touch the inked surface (the side that faces outward when installed) with your hand. Touching it may cause printing errors. Put on the supplied gloves when handling the ink ribbon.
- When installing a used ink ribbon, align the yellow side of the unused ribbon with the arrow indicated on the label of the cassette. If the position of the yellow side is not properly aligned, the print may turn out light.
- The cassette is heavy when the ink ribbon is loaded. To prevent the cassette from dropping during handling, make sure to hold it with both hands.
- Do not perform any work on the printer door. Do not place heavy objects or apply load on the printer. Doing so may damage it.
- During replacement, clean the four bobbin holders on the printer. If burrs produced by friction with the bobbins are attached to the bobbin holders, they may fall onto the card, ink ribbon, or retransfer film, causing printing errors.

"Cleaning the bobbin holders" (page 40)

1 Open the printer door



2 Press and hold down the cassette button, and pull out the ink ribbon cassette (on the right) to remove the ink ribbon

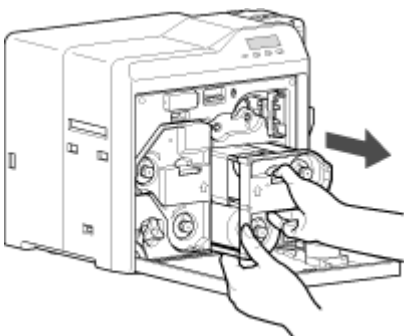

3 Install a new ink ribbon

- Install while referring to the indication on the label of the cassette.

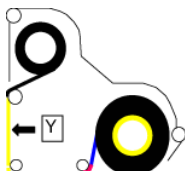

- ① With the inked surface facing outward, align the yellow side of the unused ribbon with the arrow on the cassette, and unwind it along the three shafts.
- ② Insert the ink ribbon firmly into the bobbin holders with the ribbon set to the far end of the guides.
 - A: take-up side (black)
 - B: unused side (yellow)

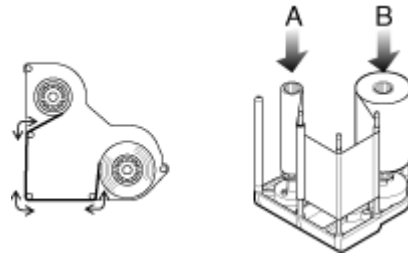

4 Remove any slack in the ink ribbon

- ① Hold the cassette.
- ② Turn the knob in the direction indicated by the arrow.

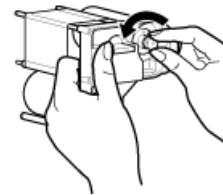

5 Insert the cassette all the way in along the guide rail until a "click" sound is heard, followed by closing the printer door

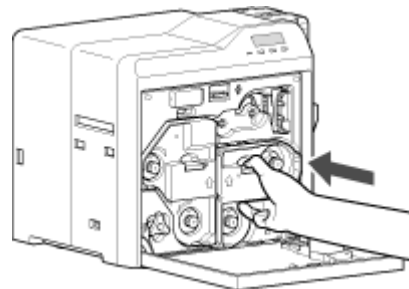
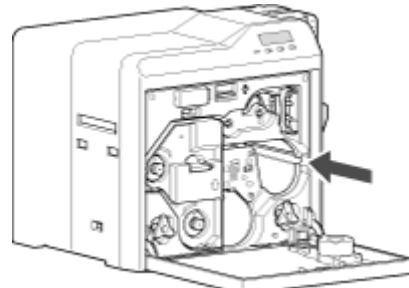

6 Press **Reset** →  to reset the printer

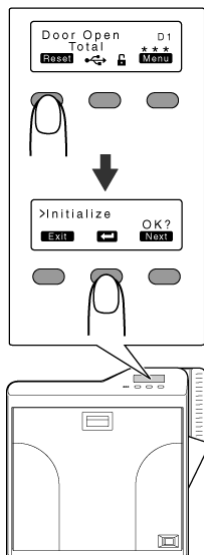

Memo:

- To avoid printing errors, it is recommended that you forward by one or two images after installing the ink ribbon cassette or retransfer film cassette.

"Initializing printer when installing the cassette" (page 22)

Retransfer Film

Retransfer Film has Run Out

- Replace with a new retransfer film.

Cautions:

- If the security lock is on, deactivate it. After work is complete, activate the security lock again.
- Stand the cassette on a flat surface as illustrated in the diagram. Avoid doing so on the floor as dust attached to it may cause printing errors.

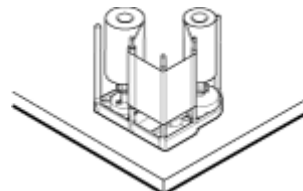

- Do not touch the retransfer face (the side that faces outward when installed) with your hand. Touching it may cause printing errors. Put on the supplied gloves when handling the retransfer film.
- The cassette is heavy when the retransfer film is loaded. To prevent the cassette from dropping during handling, make sure to hold it with both hands.
- When installing a used retransfer film, align the unused side of the film with the arrow indicated on the label of the cassette. Improper alignment may result in errors, or the print may turn out light.
- When installing a new film, make sure that at least three black lines are wound onto the take-up side. Insufficient winding may cause the printer to malfunction.
- Do not perform any work on the printer door. Do not place heavy objects or apply load on the printer. Doing so may damage it.
- During replacement, clean the four bobbin holders on the printer. If burrs produced by friction with the bobbins are attached to the bobbin holders, they may fall onto the card, ink ribbon, or retransfer film, causing printing errors.

"Cleaning the bobbin holders" (page 40)

1 Open the printer door



2 Press and hold down the cassette button, and pull out the retransfer film cassette (on the left) to remove the retransfer film

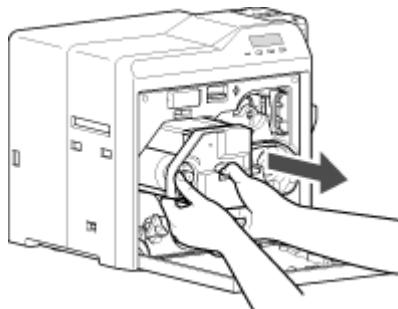

Replacement

3 Install a new retransfer film

- Install while referring to the indication on the label of the cassette.
 - ① When installing the retransfer film, make sure that at least three black lines are wound onto the take-up side.

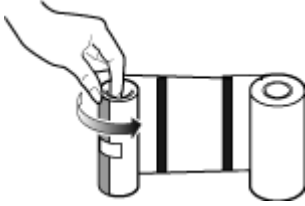

- ② With the retransfer face facing outward, align the unused side of the film with the arrow on the cassette, and unwind it along the three shafts.
 - ③ Insert the retransfer film firmly into the bobbin holders with the film set to the far end of the guides.
- A: take-up side (black)
 - B: unused side (green)

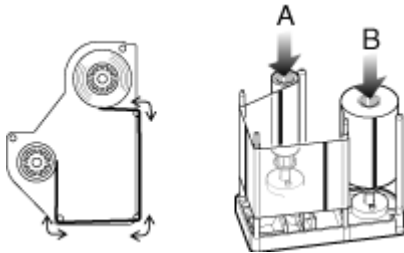

4 Remove any slack in the film

- ① Hold the retransfer film cassette.
- ② Turn the knob in the direction indicated by the arrow.

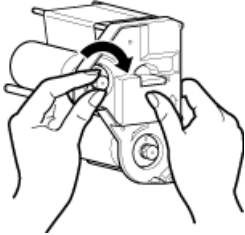

- 5 Insert the cassette all the way in along the guide rail until a “click” sound is heard, followed by closing the printer door

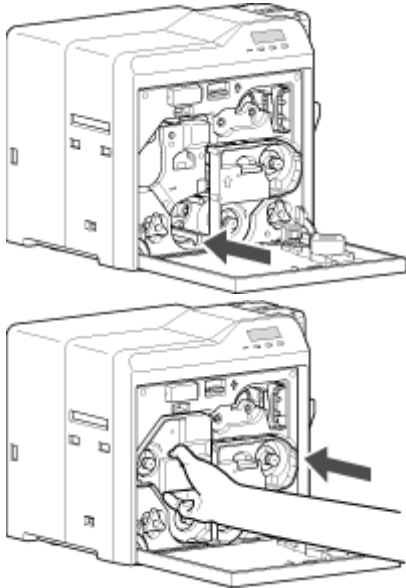

- 6 Press **Reset** →  to reset the printer

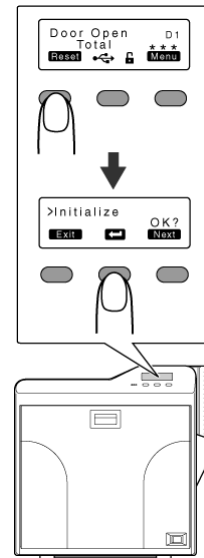

Memo:

- To avoid printing errors, it is recommended that you forward by one or two images after installing the ink ribbon cassette or retransfer film cassette.

"Initializing printer when installing the cassette" (☞ page 22)

Servicing of Parts

Request for routine servicing

- In order to prevent printing errors and malfunctions from occurring in advance, please request for routine servicing by the servicing personnel. For details on servicing, please consult our authorized dealers.

Cleaning Roller

- The function of the cleaning roller is to remove any dirt or dust attached to the card.
- The color of the printed card may appear faded or dirt may appear conspicuous if the cleaning roller is dirty. Card jams may also occur as a result.

Cautions:

- If the security lock is on, deactivate it. After work is complete, activate the security lock again.
- Start work after ensuring that the power has been turned off.
- If the printer is used every day, make sure to clean the cleaning roller daily at the end of the operation.
- Do not perform any work on the printer door. Do not place heavy objects or apply load on the printer. Doing so may damage it.
- After washing, allow the cleaning roller to dry completely before installing it to the printer.
- Do not wash the cleaning roller with anything other than water (e.g., alcohol).
- Replace the cleaning unit with a new one after using it for about one year. For details on its replacement, please consult our authorized dealers.
- After cleaning is complete, check to ensure that all dismantled parts are restored to their original positions. Failure to restore the parts may result in malfunction of the printer.

1 Open the printer door



2 Remove the cleaning unit

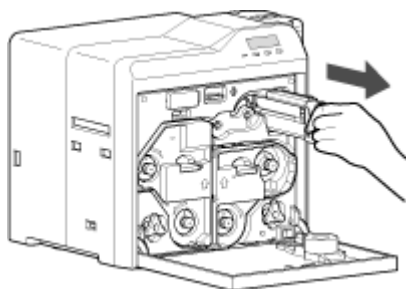

3 Wash the cleaning roller with water

- Wash the roller with water, and remove any dirt from the surface of the cleaning roller with your finger.

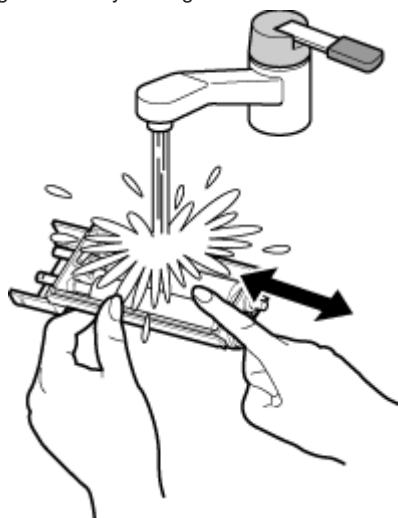

4 Allow the cleaning roller to air dry

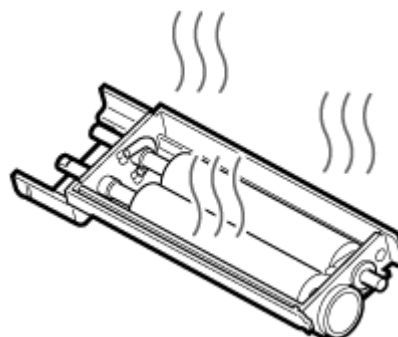

5 Set the cleaning unit, and close the printer door

- With the roller facing the right, insert it all the way in.

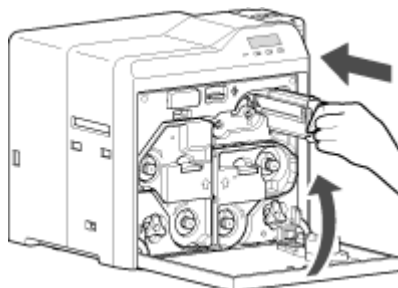

Card Load Roller

- Card jams may occur if the card load roller is dirty.

Cautions:

- If the security lock is on, deactivate it. After work is complete, activate the security lock again.
- Start work after ensuring that the power has been turned off.
- After cleaning is complete, check to ensure that all dismantled parts are restored to their original positions. Failure to restore the parts may result in malfunction of the printer.
- For details on separately sold items, please consult our authorized dealers.

1 Remove the card hopper

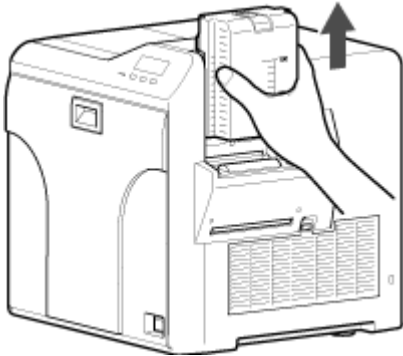

2 Apply alcohol (sold separately) to a wiper (sold separately), and use it to wipe the surface of the card load roller

- Wipe while turning the card load roller in the anti-clockwise direction.



3 Install the card hopper

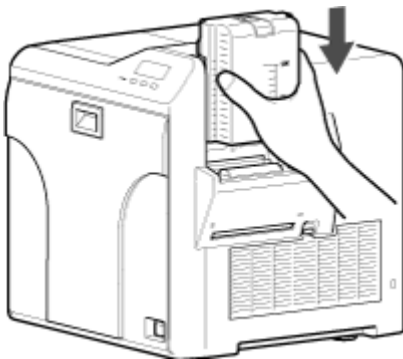

Fan Filter

- The color of the printed card may appear faded or dirt may appear conspicuous if the fan filter is dirty.
- Perform cleaning after printing about 10,000 cards.

Cautions:

- Start work after ensuring that the power has been turned off.
- After cleaning is complete, check to ensure that all dismantled parts are restored to their original positions. Failure to restore the parts may result in malfunction of the printer.
- Replace the fan filter with a new one after using it for about one year. For details on its replacement, please consult our authorized dealers.

1 Remove the filter cover located on the side of the printer

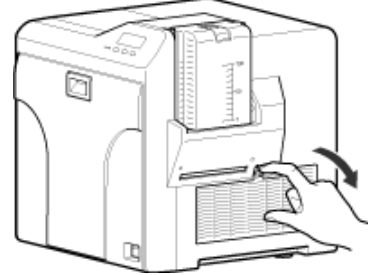

2 Remove the fan filter

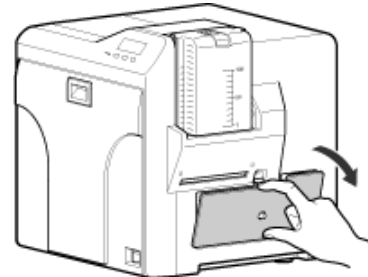

3 Remove any dirt that is attached to the fan filter using a vacuum cleaner

- Hold the filter with your hand to prevent it from being sucked into the vacuum cleaner.

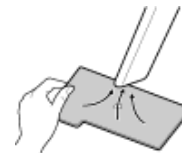

4 Set the fan filter

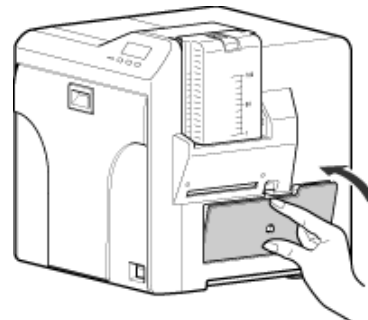

5 Set the filter cover

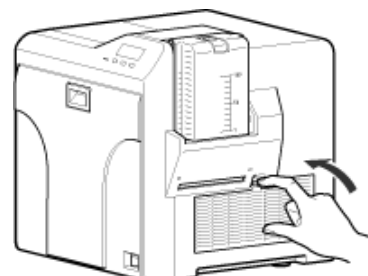

Card Feed Roller/Heating Roller

- The color of the printed card may appear faded or dirt may appear conspicuous if the card feed roller or heating roller is dirty.
- Perform cleaning after printing about 1,000 cards.

Cautions:

- If the security lock is on, deactivate it. After work is complete, activate the security lock again.
- Before cleaning the card feed roller and heating roller, make sure that you clean the cleaning roller. Otherwise, dirt on the cleaning roller may be attached to the cleaning card, causing its cleaning capability to deteriorate.
- Stand the cassette on a flat surface as illustrated in the diagram. Avoid doing so on the floor as dust attached to it may cause printing errors.

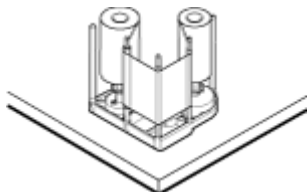

- If card jam occurs when the cleaning card is inserted, turn off and on the power of the printer. Doing so automatically discharges the card.
- Do not perform any work on the printer door. Do not place heavy objects or apply load on the printer. Doing so may damage it.
- Each cleaning card can only be used once. Reusing a dirty card may dirty the roller or cause the printer to malfunction.
- After cleaning is complete, check to ensure that all dismantled parts are restored to their original positions. Failure to restore the parts may result in malfunction of the printer.
- For details on separately sold items, please consult our authorized dealers.

1 Open the printer door. Press and hold down the cassette button, and remove the retransfer film cassette (on the left)

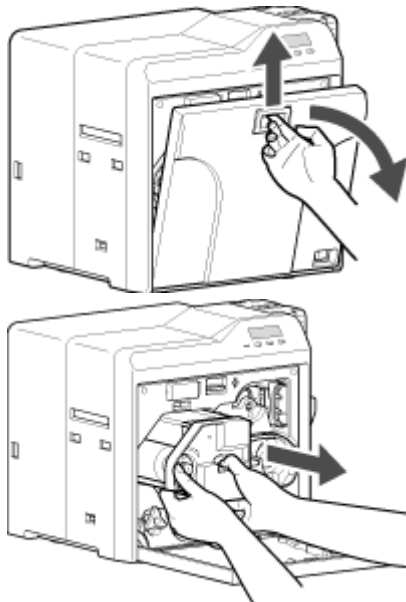

2 Close the printer door

3 Remove the card hopper

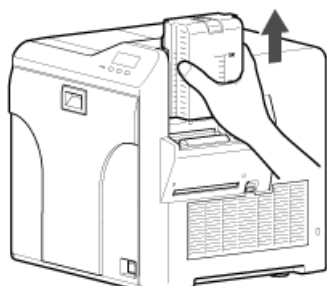

4 Turn on the power

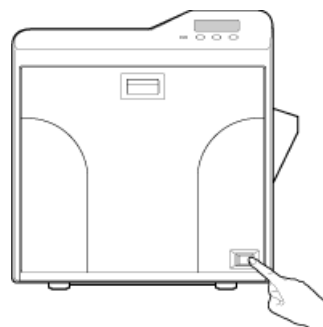

5 Press **Menu** to set to [Cleaning]

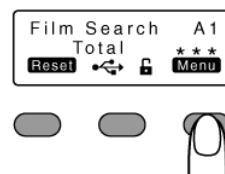

6 Press **Enter** to set to [Rollers]

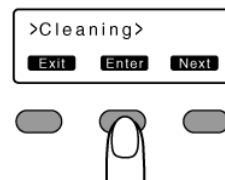

7 Press **Left Arrow**

- A [Film Checking..] message appears, followed by a [Cleaning Start OK?] message.

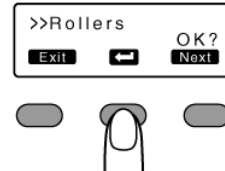

8 Peel off the backing paper from the cleaning card (sold separately)



9 Press

- A [Cleaning..] message appears.

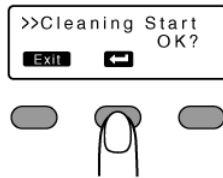

Cautions:

- If the retransfer heating roller is hot, a [HR is too hot!] message will be displayed. Turn off the power, and perform cleaning after the retransfer heating roller has cooled down completely.

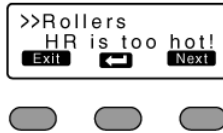

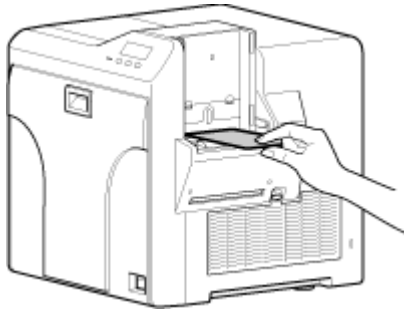

10 Insert the cleaning card (sold separately) within 20 seconds

- The roller draws in the card, and cleaning starts automatically.
- A [Cleaning Start OK?] message appears after the card is discharged.



Cautions:

- Insert the card within 20 seconds after pressing .
- After pressing , the buzzer sounds upon a lapse of 20 seconds, and a [Jam(Hopper)] error message appears about 10 seconds later. Press **Reset**  to cancel the error.
- When a standard-sized card is inserted, the card is automatically discharged from the NG card outlet, and a [Cleaning Start OK?] message appears.

11 Press , and insert the cleaning card again

- Reverse the adhesive face, and insert the card.

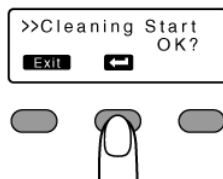

- ## 12 After the cleaning card is discharged, turn off the power, install the retransfer film cassette, close the printer door, and install the card hopper

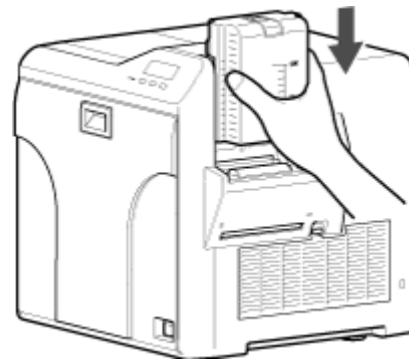
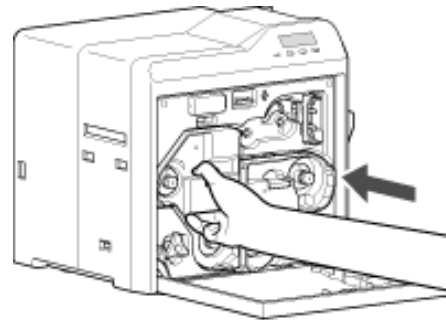
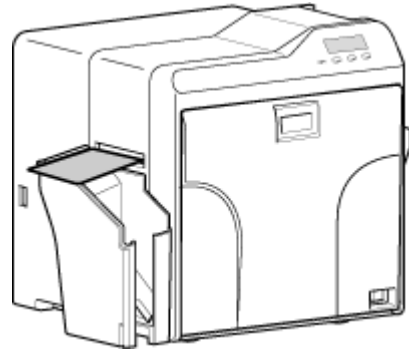

- To turn on the power again, do so after an interval of at least 10 seconds.

Magnetic Head

- If the magnetic head is dirty, errors may occur during writing to or reading of the magnetic stripe card.
- Clean the magnetic head after approximately every 1,000 cards.

Cautions:

- If the security lock is on, deactivate it. After work is complete, activate the security lock again.
- Before cleaning the magnetic head, make sure that you clean the cleaning roller. Otherwise, dirt on the cleaning roller may be attached to the cleaning card, causing its cleaning capability to deteriorate.
- After cleaning is complete, check to ensure that all dismantled parts are restored to their original positions. Failure to restore the parts may result in malfunction of the printer.
- Do not perform any work on the printer door. Do not place heavy objects or apply load on the printer. Doing so may damage it.
- For details on separately sold items, please consult our authorized dealers.
- Replace the magnetic head cleaning card accordingly if it has become dirty. Using a dirty card may dirty the head and cause malfunction.

1 Turn on the power

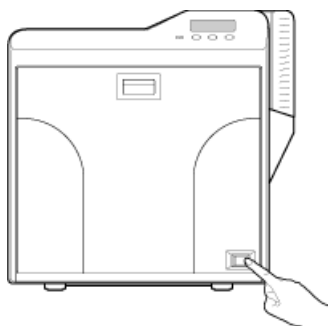

2 Check to ensure that [Ready] or [Preheating..] is displayed on the operation panel of the printer

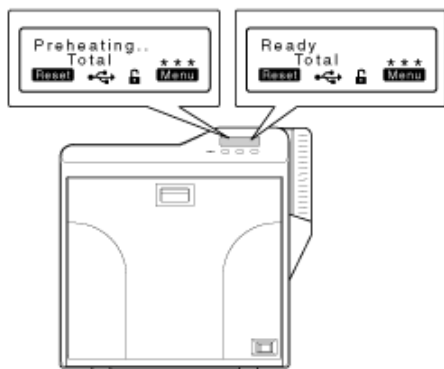

3 Remove the card hopper

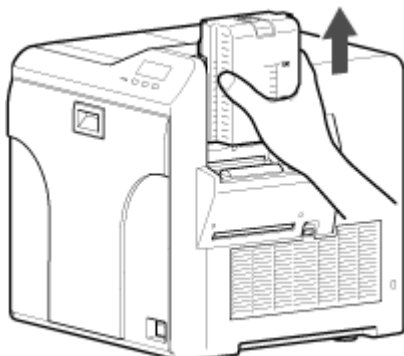

4 Press **Menu** to set to [Cleaning]

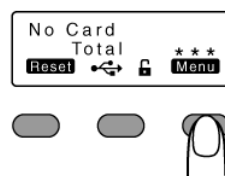

5 Press **Enter** → **Next** to set to [MG]

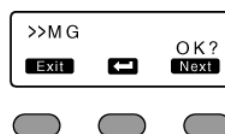
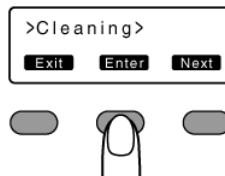

6 Apply alcohol on the magnetic head cleaning card (sold separately)

- Apply about three to four drops of alcohol on the position of the magnetic stripe.



7 Press **Left Arrow**

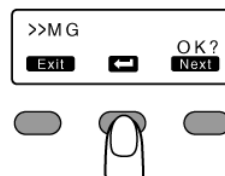

8 Insert the magnetic head cleaning card within 20 seconds

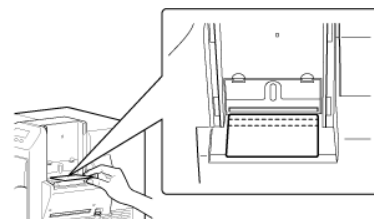

Cautions:

- Insert the card within 20 seconds after pressing **Left Arrow**.
- After pressing **Left Arrow**, the buzzer sounds upon a lapse of 20 seconds, and a [Jam(Hopper)] error message appears about 10 seconds later. Press **Reset** → **Left Arrow** to cancel the error.

- 9 After the cleaning card is discharged, turn off the power, and install the card hopper

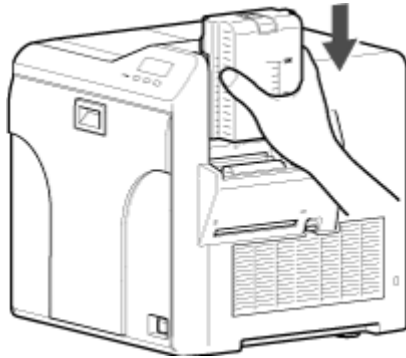
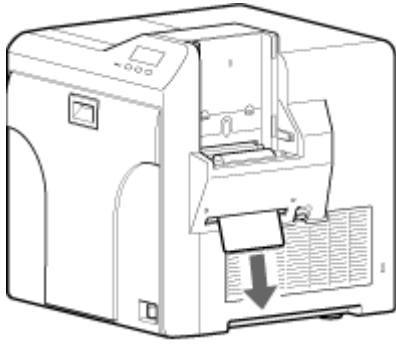

- To turn on the power again, do so after an interval of at least 10 seconds.

Bobbin Holders

- If burrs produced by friction with the bobbins are attached to the bobbin holders, they may fall onto the card, ink ribbon, or retransfer film, causing printing errors.

Cautions:

- If the security lock is on, deactivate it. After work is complete, activate the security lock again.
- Start work after ensuring that the power has been turned off.
- Stand the cassette on a flat surface as illustrated in the diagram. Avoid doing so on the floor as dust attached to it may cause printing errors.

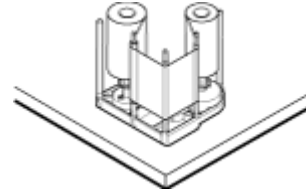

- Do not perform any work on the printer door. Do not place heavy objects or apply load on the printer. Doing so may damage it.
- Perform cleaning each time you replace the ink ribbon or retransfer film.
- After cleaning is complete, check to ensure that all dismantled parts are restored to their original positions. Failure to restore the parts may result in malfunction of the printer.
- For details on separately sold items, please consult our authorized dealers.

1 Open the printer door

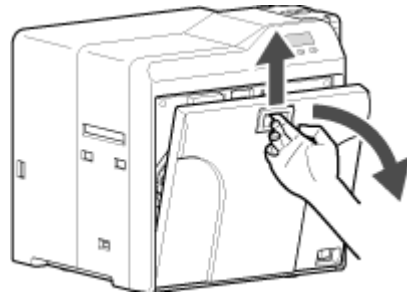

- 2 Press and hold down the cassette button, and remove the ink ribbon cassette (on the right)

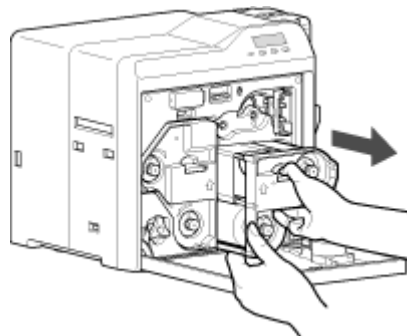

- 3 Press and hold down the cassette button, and remove the retransfer film cassette (on the left)

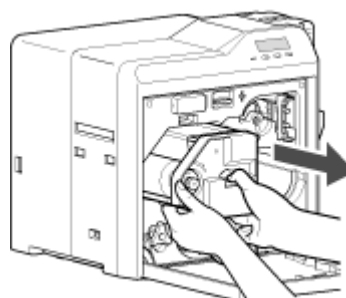

- 4 Apply alcohol to a cotton swab (large), and use it to wipe the four bobbin holders
(Cotton swab and alcohol: sold separately)

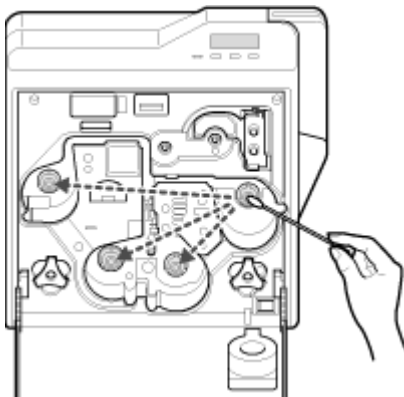

- 5 Insert the retransfer film cassette along the guide rail until a "click" sound is heard

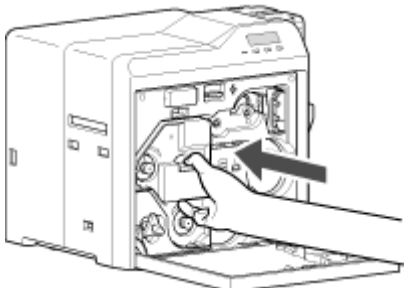
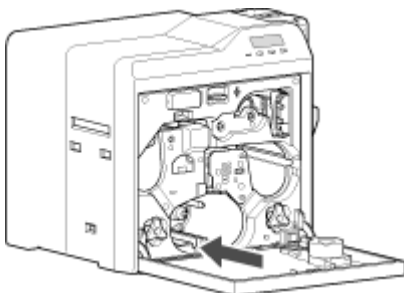

- 6 Insert the ink ribbon cassette along the guide rail until a "click" sound is heard, followed by closing the printer door

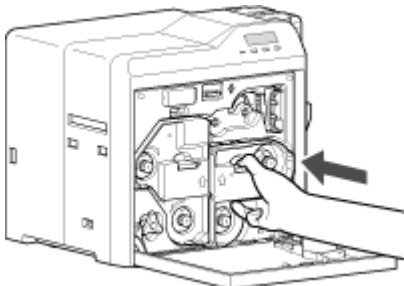
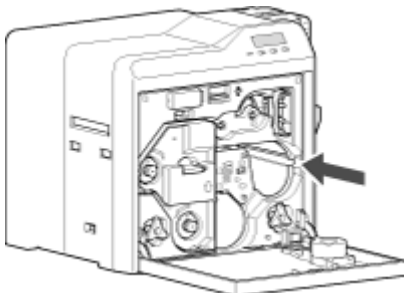

Thermal Head

- Lines may appear on the card after printing if the thermal head is dirty.
- Clean the thermal head after printing about 10,000 images.

Cautions:

- If the security lock is on, deactivate it. After work is complete, activate the security lock again.
- Start work after ensuring that the power has been turned off.
- Stand the cassette on a flat surface as illustrated in the diagram. Avoid doing so on the floor as dust attached to it may cause printing errors.

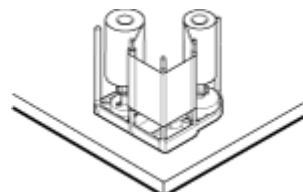

- Do not perform any work on the printer door. Do not place heavy objects or apply load on the printer. Doing so may damage it.
- Touching the thermal head with your body electrostatically charged may cause damage to the head. Make sure that you touch the metallic part of the printer before commencing work.
- Pay attention to prevent metallic objects from knocking against the thermal head. Doing so may damage it.
- After cleaning is complete, check to ensure that all dismantled parts are restored to their original positions. Failure to restore the parts may result in malfunction of the printer.
- For details on separately sold items, please consult our authorized dealers.

- 1 Open the printer door



- 2 Press and hold down the cassette button, and remove the ink ribbon cassette (on the right)

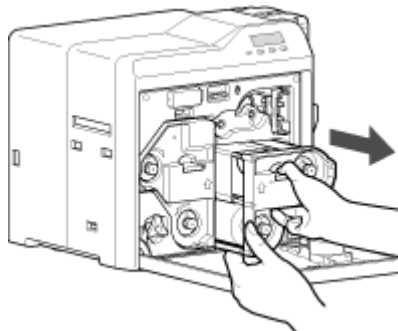

- 3 Press and hold down the cassette button, and remove the retransfer film cassette (on the left)



Maintenance

4 Apply alcohol to a cotton swab (large), and use it to wipe the thermal head
(Cotton swab and alcohol: sold separately)

- Wipe the thermal head with care in the horizontal direction.

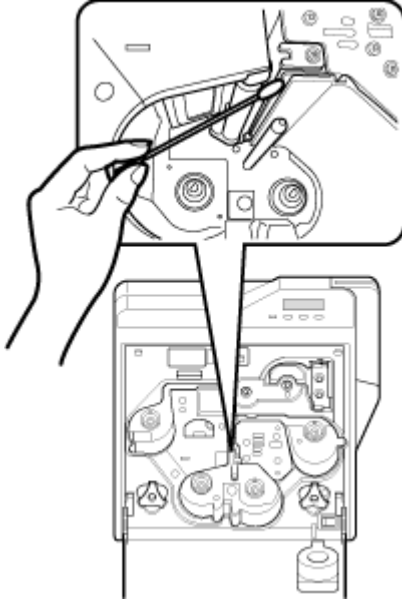

6 Insert the ink ribbon cassette along the guide rail until a “click” sound is heard, followed by closing the printer door

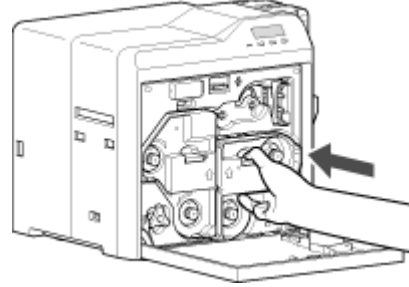
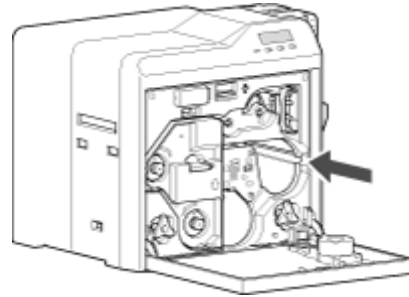

5 Insert the retransfer film cassette along the guide rail until a “click” sound is heard

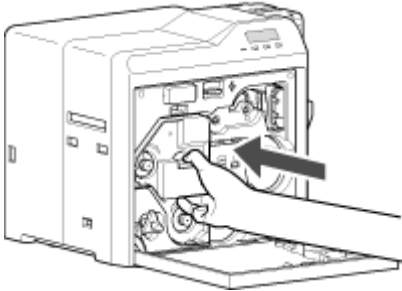
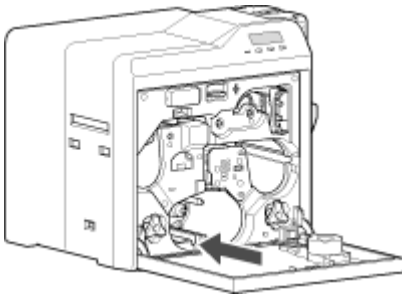

Servicing Based on Print Output

Colors Appear Faded or Dirt is Conspicuous

- "Clean the cleaning roller." (☞ page 35)
 - "Clean the fan filter." (☞ page 36)
 - "Clean the card feed roller/heating roller." (☞ page 37)
 - "Clean the bobbin holders." (☞ page 40)
-

Card Jam

- "Clean the cleaning roller." (☞ page 35)
 - "Clean the card load roller." (☞ page 36)
-

Error During Writing to or Reading of Magnetic Stripe Card

- "Clean the magnetic head." (☞ page 39)
-

Lines Appear on Card after Printing

- "Clean the thermal head." (☞ page 41)

When an Error Message is Displayed

- Check the error code and error code number displayed on the operation panel.

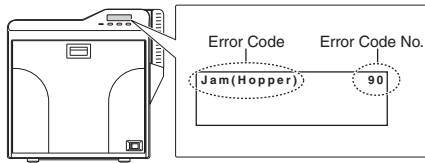

List of Error Codes

- Click on an error code below to jump to the page with the corresponding error descriptions.

"44" (page 45) "90" (page 44) "91" (page 44)
 "92" (page 44) "93" (page 44) "94" (page 44)
 "95" (page 44)
 "A1" (page 44) "A2" (page 44) "A8" (page 44)
 "AB" (page 45) "AC" (page 45)
 "B0" (page 44) "B1" (page 44) "B2" (page 45)
 "C1" (page 45) "C2" (page 45) "C3" (page 45)
 "D1" (page 44) "D8" (page 45)
 "F0" (page 45) "F1" (page 45) "F2" (page 45)
 "F3" (page 45) "F4" (page 45) "F5" (page 45)
 "F6" (page 45) "F8" (page 45)

No Card



- Cards have run out.
"Replenish the cards." (page 31)
- The card hopper is not installed.
Install the card hopper.

Memo:

- The operation panel display appears blinking when the cards have run out or when the card hopper is not installed.

Jam(Hopper) 90

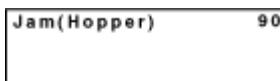

- Card jam near the card hopper and cleaning roller.
"Remove the jammed card." (page 46)

Jam(TurnOver) 91

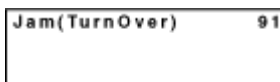

- Card jam near the card turn over unit.
"Remove the jammed card." (page 47)

Jam(MG) 92

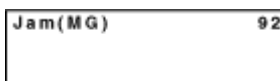

- Card jam in the magnetic encoder unit.
"Remove the jammed card." (page 49)

Jam(Transfer) 93

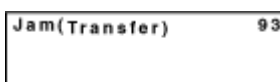

- Card jam in the card feed roller.
"Remove the jammed card." (page 50)

Jam(Discharge) 94

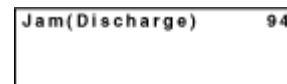

- Card jam near the card outlet.
"Remove the jammed card." (page 51)

Jam(Retran.) 95

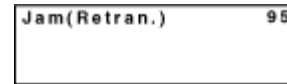

- Card jam near the retransfer heating roller.
"Remove the jammed card." (page 52)

Film Search A1



- Retransfer film is broken.
"Repair the retransfer film." (page 56)

MG Test Err A8

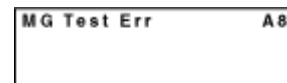

- A writing error has occurred during magnetic encoder self-diagnosis.
Press **Reset** → **←** to reset the printer.

Ink Error B0



- An incorrect ink ribbon is installed.
Install a correct ink ribbon.

Ink Search B1

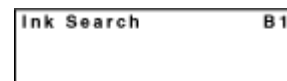

- Ink ribbon is broken.
"Repair the ink ribbon." (page 54)

Door Open D1



- The printer door is open.
Close the printer door, and press **Reset** → **←** to reset the printer.
- Cleaning unit is not installed.
Install the cleaning unit, close the printer door, and press **Reset** → **←** to reset the printer.

Memo:

- The operation panel display appears blinking when the printer door is open or when the cleaning unit is not installed.

Film Run Out A2

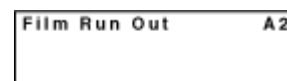

- Retransfer film has run out.
"Replace with a new one." (page 33)

Ink Run Out B2

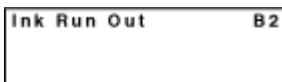

- Ink ribbon has run out.
"Replace with a new one." (☞ page 32)

Hardware 44



- A hardware failure has occurred on the printer.
Turn off and on the power again. If the same problem recurs, turn off the power and consult our authorized dealers.

MG Mechanical AB

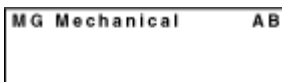

- An error has occurred in the mechanical component of the magnetic encoder.
Turn off and on the power again. If the same problem recurs, turn off the power and consult our authorized dealers.

MG Hardware AC

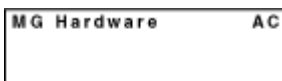

- A hardware failure has occurred on the magnetic encoder.
Turn off and on the power again. If the same problem recurs, turn off the power and consult our authorized dealers.

Cam Error C1

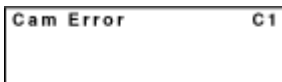

- A heating roller operation error has occurred.
Turn off and on the power again. If the same problem recurs, turn off the power and consult our authorized dealers.

HR Overheat C2



- The temperature of the bend remedy heating roller or retransfer heating roller is too high.
Turn off and on the power again. If the same problem recurs, turn off the power and consult our authorized dealers.

Hardware D8



- A hardware error has occurred during initialization.
Turn off and on the power again. If the same problem recurs, turn off the power and consult our authorized dealers.

TR Overheat F0



- The temperature of the retransfer heating roller is too high.
Turn off and on the power again. If the same problem recurs, turn off the power and consult our authorized dealers.

TR Heater F1



- The retransfer heating roller is faulty.
Turn off and on the power again. If the same problem recurs, turn off the power and consult our authorized dealers.

TR Thermister F2



- The retransfer heating roller thermistor is faulty.
Turn off and on the power again. If the same problem recurs, turn off the power and consult our authorized dealers.

RR Overheat F3



- The temperature of the bend remedy heating roller is too high.
Turn off and on the power again. If the same problem recurs, turn off the power and consult our authorized dealers.

RR Heater F4



- The bend remedy unit is faulty.
Turn off and on the power again. If the same problem recurs, turn off the power and consult our authorized dealers.

RR Thermister F5



- The bend remedy heating roller thermistor is faulty.
Turn off and on the power again. If the same problem recurs, turn off the power and consult our authorized dealers.

Overcool F6



- The operating ambient temperature of the printer is too low.
Check the temperature. If the same problem recurs within the range of operating ambient temperature, turn off the power and consult our authorized dealers.

Head Overheat F8



- The temperature of the thermal head is too high.
Turn off and on the power again. If the same problem recurs, turn off the power and consult our authorized dealers.

Power Intrpt C3

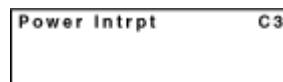

- An instantaneous interruption is detected.
Turn off and on the power again. If the same problem recurs, turn off the power and consult our authorized dealers.

Cards

Cards have Run Out

- "Replenish the cards." (☞ page 31)

Card Jam

- Error codes are displayed on the operation panel according to the location of the card jam.
- Check the error code, and remove the card according to the corresponding procedure.

Cautions:

- If the card cannot be removed, do not try to do so forcibly. Consult our authorized dealers or the servicing personnel.
- If the security lock is on, deactivate it. After work is complete, activate the security lock again.
- Do not apply excessive force on the card hopper. Doing so may damage it.
- Do not touch the printing surface of the card. Touching it may cause printing errors. Put on the supplied gloves when handling the cards.

Error Code Jam(Hopper) 90

- Card jam near the card hopper and cleaning roller.

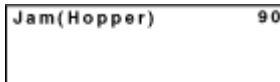

- 1 Detach the card hopper cover, and remove the unused cards

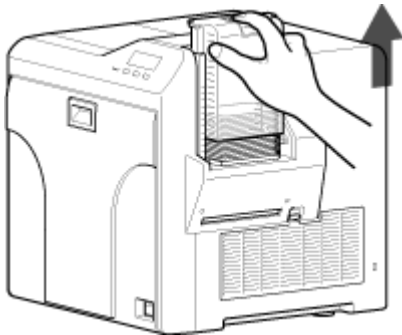

- 2 Remove the jammed card with a hand

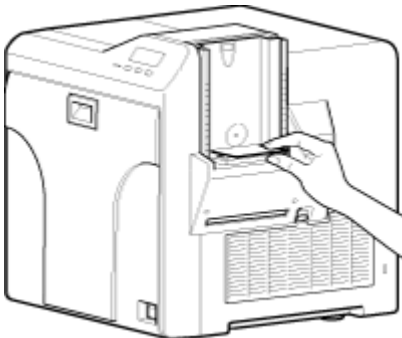

"If the card cannot be removed by hand" (☞ page 46)

- 3 Return the unused cards to their original position

- 4 Install the card hopper cover

■ If the card cannot be removed by hand

- ① Press **Reset** → to reset the printer



- The card is discharged from the NG card outlet.

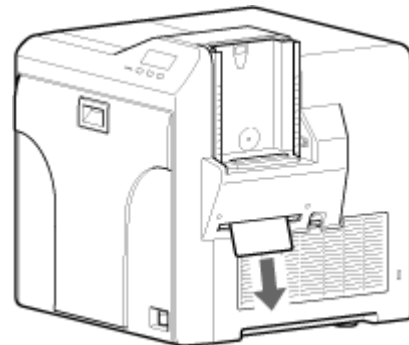

"Go to step 3" (☞ page 46)

"If the card cannot be discharged" (☞ page 47)

■ If the card cannot be discharged

- ① Turn off the power
- ② Open the printer door, and check the position of the jammed card



- ③ Attach the jog dial to the cleaning roller shaft

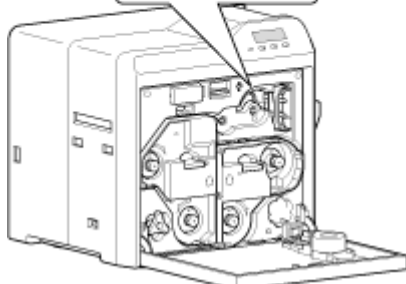
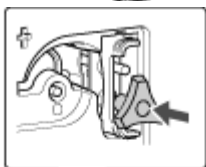
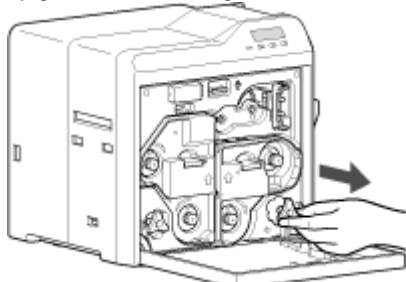

- ④ Turn the cleaning roller shaft in the clockwise direction, while checking the position of the card

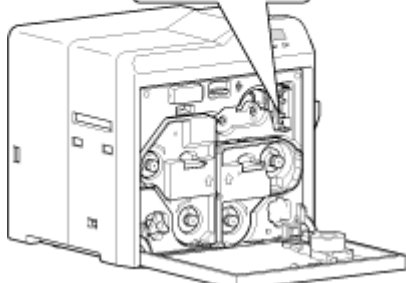
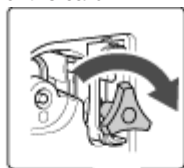

- ⑤ Remove the card after it is discharged from the card load slot

Cautions:

- If the card cannot be removed, do not try to do so forcibly. Consult our authorized dealers or the servicing personnel.

- ⑥ Restore the jog dial to its original position, and close the printer door

- ⑦ Turn on the power
"Go to step 3" (☞ page 46)

Error Code Jam(TurnOver) 91

- Card jam near the card turn over unit.



- 1 Turn off the power
- 2 Remove the card hopper

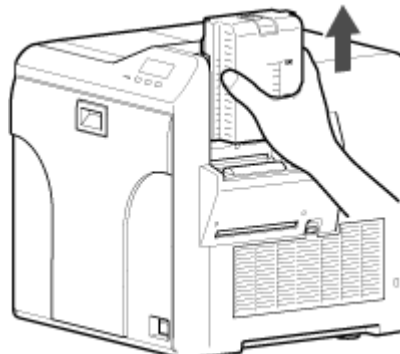

- 3 Detach the card load slot cover

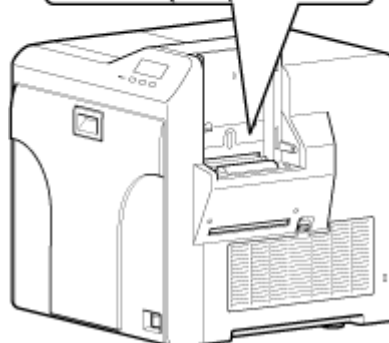

- 4 Open the printer door, and remove the cleaning unit

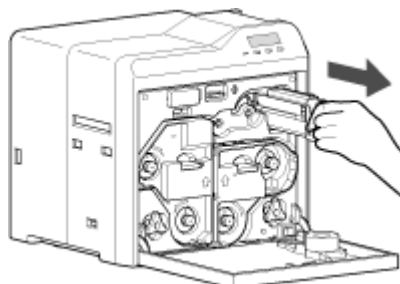

Troubleshooting

- 5 Remove the jammed card in the card turn over unit from the card load slot

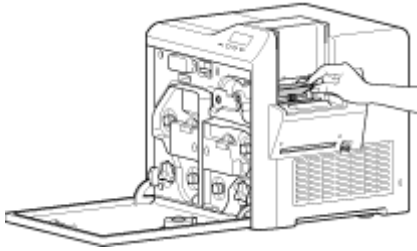

"If the card cannot be removed" (see page 48)

- 6 Install the cleaning unit

- 7 Attach the jog dial to the card turn over unit shaft, and set the card turn over unit to "Home Pos."

- "Home Pos." is the position where the slit on the jog dial points to the right and the card turn over unit is horizontal.

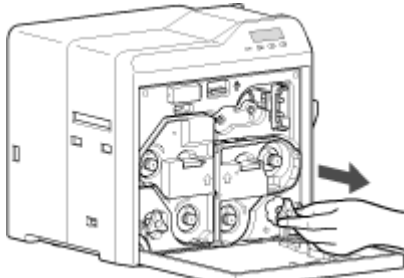

Home Pos.

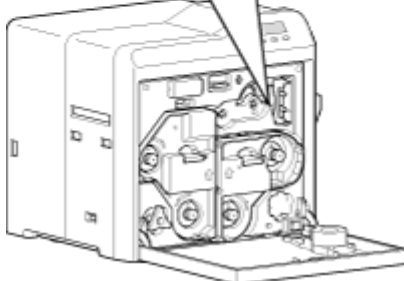
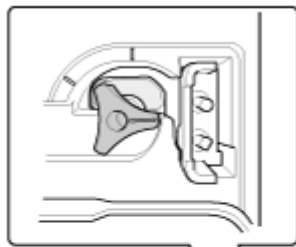

- 8 Restore the jog dial to its original position

- 9 Install the card load slot cover and card hopper, and close the printer door

- 10 Turn on the power

Cautions:

- When a Jam(TurnOver) error occurs, the [Jam(TurnOver)] message will not disappear after removing the jammed card until the card turn over unit is set to "Home Pos."
- If the printer door is opened when a Jam(TurnOver) error occurs, a [Please Adjust Turn Unit Pos!] message will be displayed. Remove the jammed card, and set the card turn over unit to "Home Pos."

■ If the card cannot be removed

- ① Install the cleaning unit
- ② Attach the jog dial to the cleaning roller shaft and card turn over unit shaft

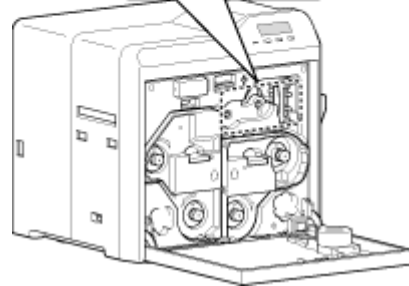
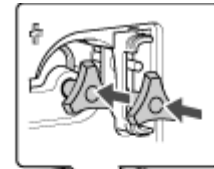
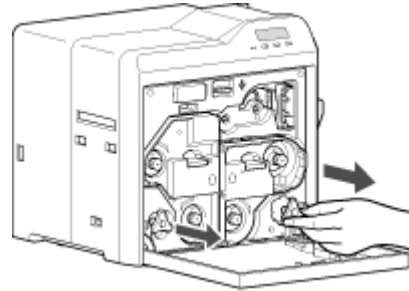

- ③ Set the card turn over unit to "Home Pos."

- "Home Pos." is the position where the slit on the jog dial points to the right and the card turn over unit is horizontal.

Home Pos.

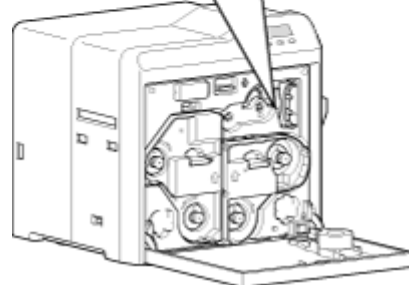
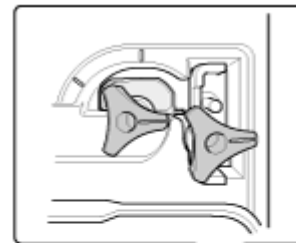

- If the card protrudes from the card turn over unit, turn the cleaning roller shaft to move the card into the unit.

- Turning the card turn over unit moves the card inside the unit outward. Turn the card turn over unit while turning the cleaning roller shaft so that the card is retained inside the card turn over unit, and set to "Home Pos."

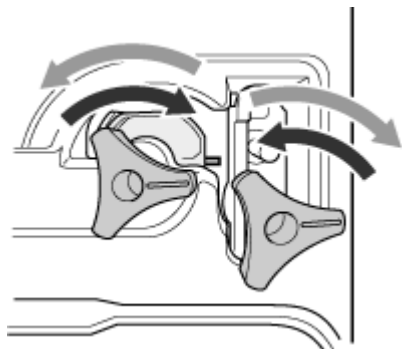

Cautions:

- Do not turn the card turn over unit forcibly with the jog dial. Doing so may break the card turn over unit.

- ④ Turn the cleaning roller shaft in the clockwise direction

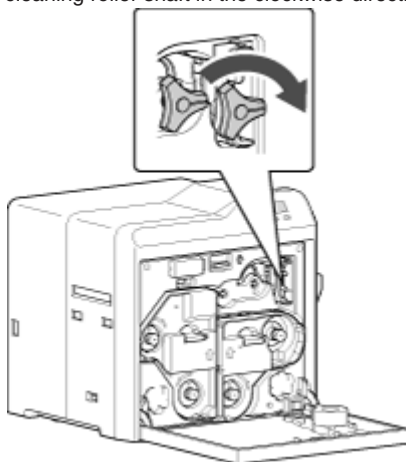

- ⑤ Remove the card after it is discharged from the card load slot

Cautions:

- If the card cannot be removed, do not try to do so forcibly. Consult our authorized dealers or the servicing personnel.

"Go to step 8" (page 48)

Error Code Jam(MG) 92

- Card jam in the magnetic encoder unit.

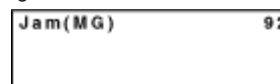

- 1 Press **Reset** to reset the printer

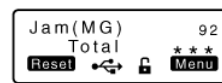

- The card is discharged from the NG card outlet.

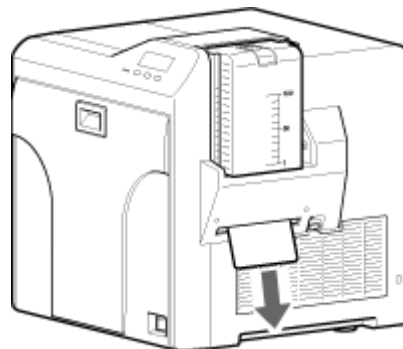

Error Code Jam(Transfer) 93

- Card jam in the card feed roller.

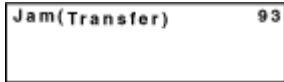

1 Press **Reset** → to reset the printer



- The card is discharged from the NG card outlet.

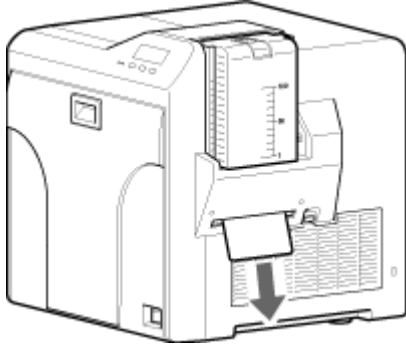

■ If the card cannot be discharged

- ① Turn off the power, and detach the card hopper

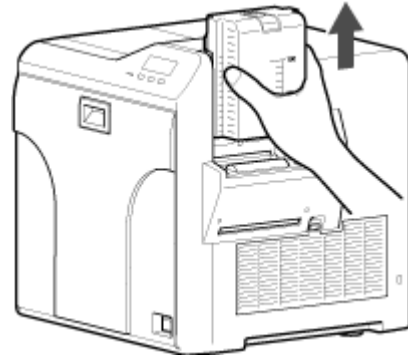

- ② Open the printer door, and check the position of the jammed card
- ③ Attach the jog dial to the card feed roller shaft and cleaning roller shaft

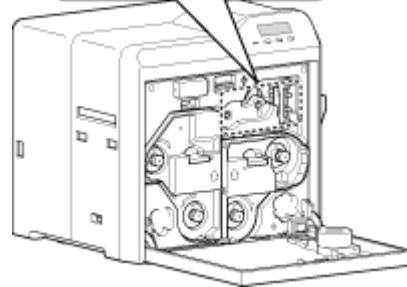
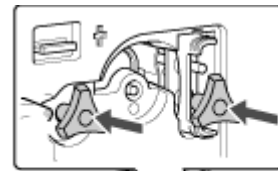
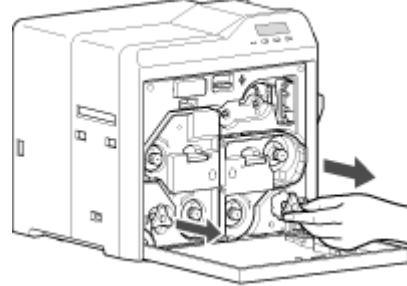

- ④ Turn the card feed roller shaft and cleaning roller shaft in the clockwise direction, while checking the position of the card

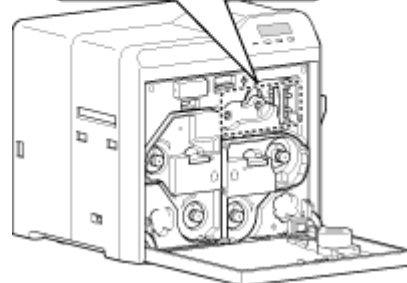
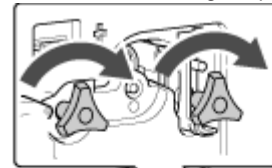

- Remove the card after it is discharged from the card load slot. (For single-sided printers, the card is discharged from the NG card outlet.)

Cautions:

- If the card cannot be removed, do not try to do so forcibly. Consult our authorized dealers or the servicing personnel.

- ⑤ Restore the jog dial to its original position
- ⑥ Install the card hopper, and close the printer door
- ⑦ Turn on the power

Error Code Jam(Discharge) 94

- Card jam near the card outlet.



1 Press **Reset** → to reset the printer



- The card is discharged from the card outlet.



■ **If the card cannot be discharged**

- ① Turn off the power, and open the printer door
- ② Pull out the retransfer film cassette, and check the position of the card

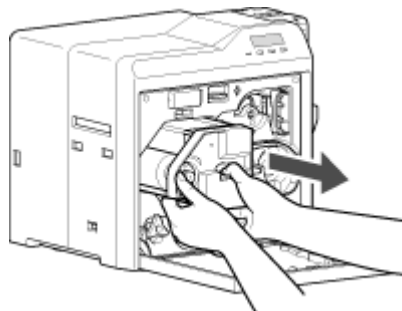

- ③ Attach the jog dial to the card feed roller shaft

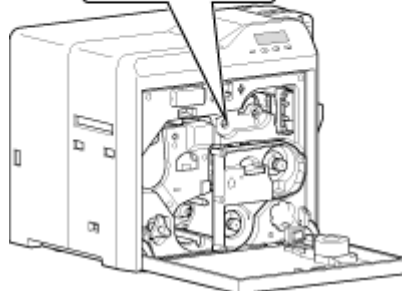
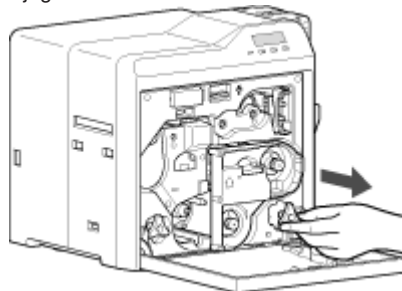

- ④ Turn the card feed roller shaft in the anti-clockwise direction, while checking the position of the card

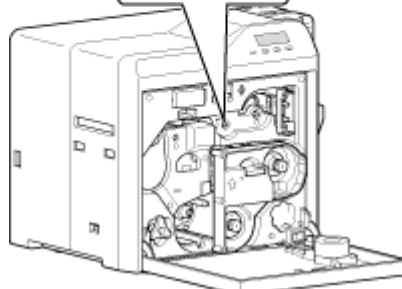

- The card is discharged from the card outlet.

Cautions:

- If the card cannot be removed, do not try to do so forcibly. Consult our authorized dealers or the servicing personnel.

- ⑤ Restore the jog dial to its original position, and install the retransfer film cassette
- ⑥ Close the printer door, and turn on the power

Error Code Jam(Retran.) 95

- Card jam near the retransfer heating roller.

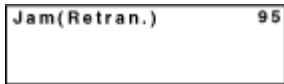

1 Open the printer door

- A [Please Remove Jam Card!] or [Please Close Door] message appears.

2 Pull out the retransfer film cassette

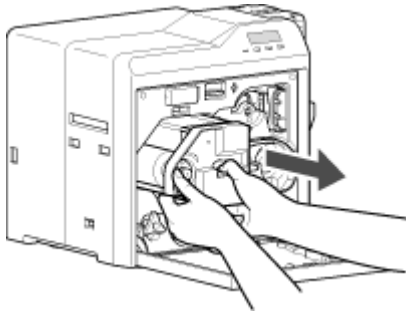

Cautions:

- The card may be adhered to the retransfer film. Pull out the retransfer film while taking care not to jam it.
- If a [Please Close Door] message is displayed, the retransfer film is stuck and the retransfer film cassette cannot be removed. In this case, close the printer door before pulling out the retransfer film cassette.

3 Remove the jammed card

"If the card is adhered to the retransfer film" (page 52)

"If the card is inside the printer unit" (page 53)

"If the card is caught in the card feed roller to the right of the retransfer heating roller" (page 53)

"If the card is caught in the card feed roller to the left of the retransfer heating roller" (page 54)

4 Install the retransfer film cassette, and close the printer door

5 Press **Reset**

- A [Jam Card Removed?] message appears.



6 Press **Yes**

Cautions:

- Initializing the printer without first removing the card will cause the printer to malfunction. Be sure to remove the card then press **Yes**.
- An [Initializing..] message appears, and initialization of the printer starts.

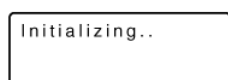
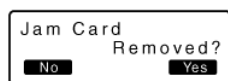

■ If the card is adhered to the retransfer film

- Remove the jammed card with a hand.

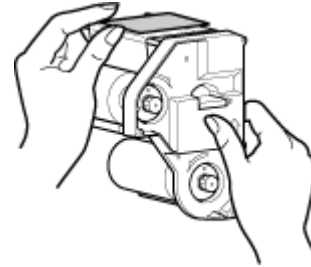

Cautions:

- The card may be very hot. Be careful not to burn your fingers when removing the card.

"Go to step 4" (page 52)

■ If the card is inside the printer unit

- If the card is not drawn into the card feed roller and is left inside the printer, use the tweezers (supplied) to remove the card.

- ① Turn off the power
- ② Check the position of the card that is left inside the printer



- ③ Pick up the card using the tip of the tweezers (supplied)
 - Be careful not to drop the card inside the printer.
- ④ Pull out the card slowly



Cautions:

- The card may be very hot. Be careful not to burn your fingers when removing the card.
- If the card cannot be removed, do not try to do so forcibly. Consult our authorized dealers or the servicing personnel.

Memo:

Example of how to pick up the card



- Pick up the card by following the diagram above.

- ⑤ Install the retransfer film cassette, and close the printer door

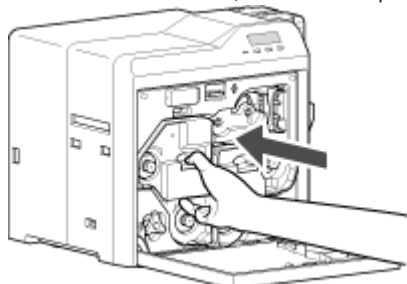

- ⑥ Turn on the power
"Go to step 5" (☞ page 52)

■ If the card is caught in the card feed roller to the right of the retransfer heating roller

- ① Turn off the power, and detach the card hopper

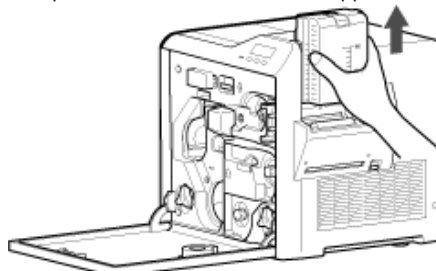

- ② Check the position of the card
- ③ Attach the jog dial to the card feed roller shaft and cleaning roller shaft

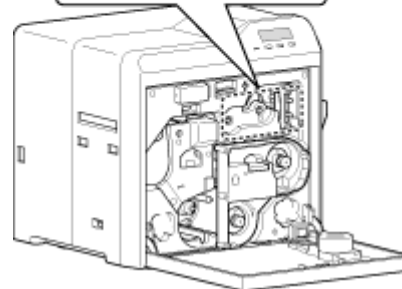
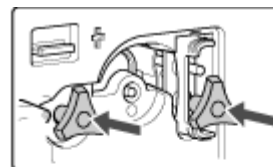
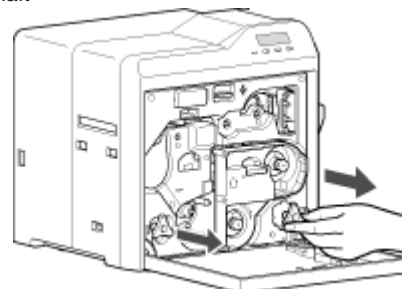

- ④ Turn the card feed roller shaft and cleaning roller shaft in the clockwise direction, while checking the position of the card

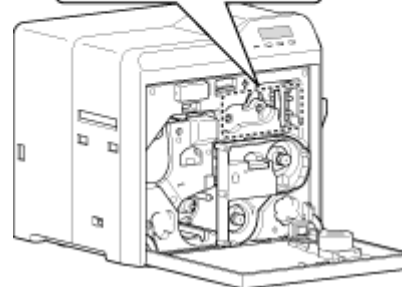

- Remove the card after it is discharged from the card load slot. (For single-sided printers, the card is discharged from the NG card outlet.)

Cautions:

- If the card cannot be removed, do not try to do so forcibly. Consult our authorized dealers or the servicing personnel.

- ⑤ Restore the jog dial to its original position, and install the card hopper
- ⑥ Install the retransfer film cassette, and close the printer door
- ⑦ Turn on the power
"Go to step 5" (☞ page 52)

■ If the card is caught in the card feed roller to the left of the retransfer heating roller

- ① Turn off the power
- ② Check the position of the card
- ③ Attach the jog dial to the card feed roller shaft

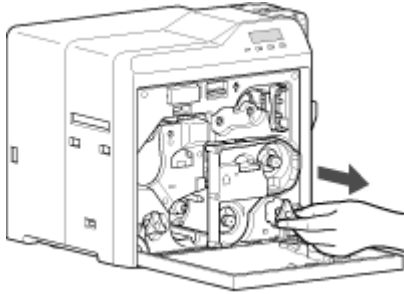

- ④ Turn the card feed roller shaft in the anti-clockwise direction, while checking the position of the card



- The card is discharged from the card outlet.

Cautions:

- If the card cannot be removed, do not try to do so forcibly. Consult our authorized dealers or the servicing personnel.

- ⑤ Restore the jog dial to its original position
- ⑥ Install the retransfer film cassette, and close the printer door
- ⑦ Turn on the power
"Go to step 5" (page 52)

Ink Ribbon

Ink Ribbon has Run Out

- "Replace with a new ink ribbon." (page 32)

Ink Ribbon is Broken

- Repair the ink ribbon.

Cautions:

- If the security lock is on, deactivate it. After work is complete, activate the security lock again.
- Stand the cassette on a flat surface as illustrated in the diagram. Avoid doing so on the floor as dust attached to it may cause printing errors.

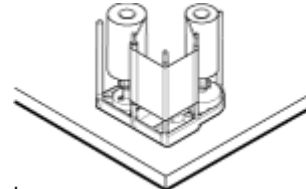

- Do not touch the inked surface (the side that faces outward when installed) with your hand. Touching it may cause printing errors. Put on the supplied gloves when handling the ink ribbon.
- The cassette is heavy when the ink ribbon is loaded. To prevent the cassette from dropping during handling, make sure to hold it with both hands.
- When installing a used ink ribbon, align the yellow side of the unused ribbon with the arrow indicated on the label of the cassette. If the position of the yellow side is not properly aligned, the print may turn out light.
- Do not perform any work on the printer door. Do not place heavy objects or apply load on the printer. Doing so may damage it.
- During replacement, clean the four bobbin holders on the printer. If burrs produced by friction with the bobbins are attached to the bobbin holders, they may fall onto the card, ink ribbon, or retransfer film, causing printing errors.

"Cleaning the bobbin holders" (page 40)

1 Open the printer door



2 Press and hold down the cassette button, and remove the ink ribbon cassette (on the right)

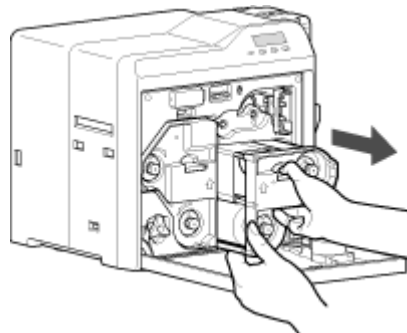

3 Cut away the broken portion, and attach the unused portion at the supply side to the other end at the take-up side using an adhesive tape, while making sure that the joint surface is even

Cautions:

- Do not discard the used ribbon at the take-up side.

4 Turn the take-up side using your hand until the broken portion can no longer be seen

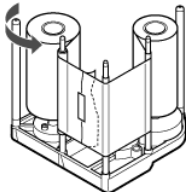

- Align the yellow side of the unused portion with the arrow indicated on the label of the cassette.

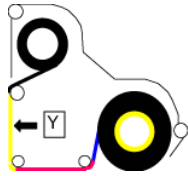

5 Remove any slack in the ink ribbon

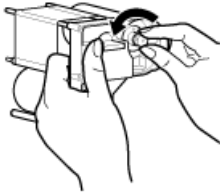

6 Insert the cassette all the way in along the guide rail until a “click” sound is heard, followed by closing the printer door

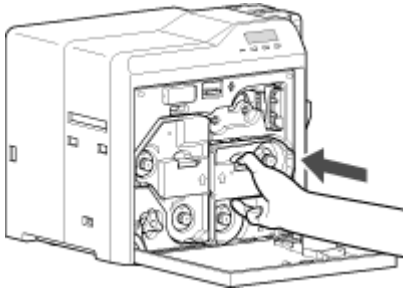
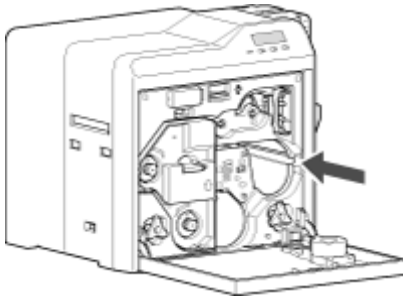

7 Press **Reset** →  to reset the printer

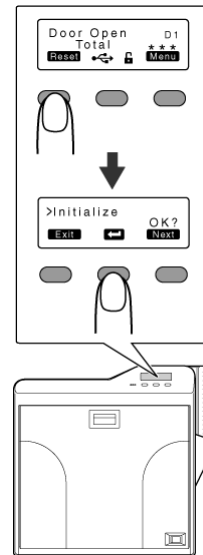

Memo:

- To avoid printing errors, it is recommended that you forward by one or two images after installing the ink ribbon cassette or retransfer film cassette.

"Initializing printer when installing the cassette" (☞ page 22)

Retransfer Film

Retransfer Film has Run Out

- "Replace with a new retransfer film." (page 33)

Retransfer Film is Broken

- Repair the retransfer film.

Cautions:

- If the security lock is on, deactivate it. After work is complete, activate the security lock again.
- Stand the cassette on a flat surface as illustrated in the diagram. Avoid doing so on the floor as dust attached to it may cause printing errors.

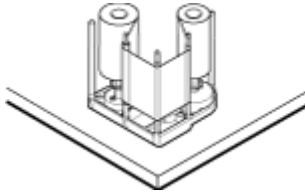

- Do not touch the retransfer face (the side that faces outward when installed) with your hand. Touching it may cause printing errors. Put on the supplied gloves when handling the retransfer film.
- The cassette is heavy when the retransfer film is loaded. To prevent the cassette from dropping during handling, make sure to hold it with both hands.
- When installing a used retransfer film, align the unused side of the film with the arrow indicated on the label of the cassette. Improper alignment may result in errors, or the print may turn out light.
- Do not perform any work on the printer door. Do not place heavy objects or apply load on the printer. Doing so may damage it.
- During replacement, clean the four bobbin holders on the printer. If burrs produced by friction with the bobbins are attached to the bobbin holders, they may fall onto the card, ink ribbon, or retransfer film, causing printing errors.

"Cleaning the bobbin holders" (page 40)

1 Open the printer door



2 Press and hold down the cassette button, and remove the retransfer film cassette (on the left)

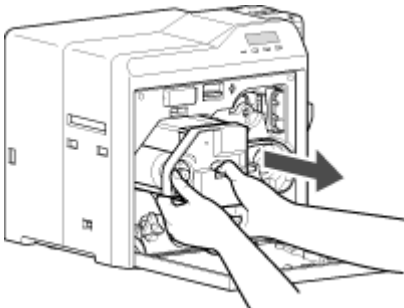

3 Cut away the broken portion, and attach the unused portion at the supply side to the other end at the take-up side using an adhesive tape, while making sure that the joint surface is even

Cautions:

- Do not discard the used retransfer film at the take-up side.

4 Turn the take-up side using your hand until the broken portion can no longer be seen

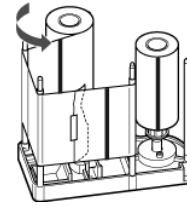

- Align the film side of the unused portion with the arrow indicated on the label of the cassette.

5 Remove any slack in the film



6 Insert the cassette all the way in along the guide rail until a "click" sound is heard, followed by closing the printer door

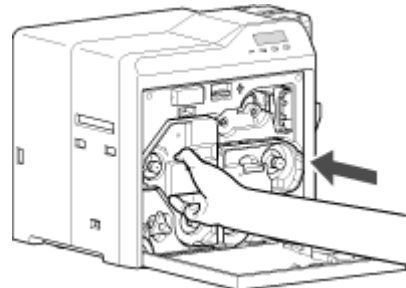
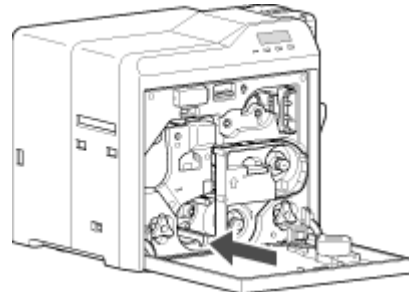

7 Press **Reset** to reset the printer

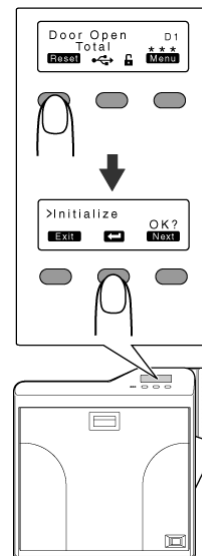

Memo:

- To avoid printing errors, it is recommended that you forward by one or two images after installing the ink ribbon cassette or retransfer film cassette.

"Initializing printer when installing the cassette" (page 22)

Unable to Fit Retransfer Film Cassette into Printer

- With the printer door closed, turn on the power to cancel the transport mode.
 - While in the transport mode, the retransfer film cassette cannot be installed to the printer with the retransfer film loaded.
- "Transport Mode Setting" (☞ page 29)

Unable to Produce Desired Printing Results

Lines Appear on Card after Printing

- "Clean the thermal head." (☞ page 41)

Colors on Card Appear Faded after Printing

- "Clean the cleaning roller." (☞ page 35)
- "Clean the fan filter." (☞ page 36)
- "Clean the card feed roller/heating roller." (☞ page 37)
- "Clean the bobbin holders." (☞ page 40)

Peeling Occurs on Card after Printing

- "Check the retransfer mode settings." (☞ page 115)

Overall Printing Quality is Poor

- "Clean the cleaning roller." (☞ page 35)
- "Clean the fan filter." (☞ page 36)
- "Clean the card feed roller/heating roller." (☞ page 37)
- "Clean the bobbin holders." (☞ page 40)
- Is the printing face of the card dirty?
Use a clean card.

Card is Printed in a Single Color

- Is the print setting set to single-color printing?
 - Is the software application setting set to single-color printing?
- Check the print settings.

Strange Characters or Images are Printed

- Is the driver for this printer selected on the computer?
Select the driver for this printer.
- Is the USB cable connection loose?
Plug in the USB cable properly.

Retransfer cannot be Performed Successfully

- Is the printing face of the card dirty?
Use a clean card.
- Is the surrounding temperature or card surface temperature too low?
Use the printer when the surrounding temperature is sufficiently high.
- Is the retransfer speed setting value too high?
Set to a value that is smaller than the standard value, +2 (i.e., between +1 and -3).
- Is the temperature of the retransfer heating roller too low?
Set to a value that is larger than the standard value, +1 (i.e., +2).

Printer not Operating as Desired

Card is not Fed into the Printer

- Is the card load roller dirty?

"Clean the card load roller." (☞ page 36)

- Is the cleaning roller dirty?

"Clean the cleaning roller." (☞ page 35)

- Is the card thickness correctly adjusted?

"Check the adjusted card thickness." (☞ page 63)

- Are the cards adhered to one another?

When using new cards, set them after making sure that they are not adhered to each other due to static.

Power does not Turn On

- Is the power switch turned off? (O position)

Turn on the power. (I position)

- Is the power cord disconnected?

Plug in the power cord properly.

- Is there electricity supply from the outlet?

Try connecting another electrical device to the outlet. If the device works normally, then it could be due to malfunctioning of the printer. Please consult our authorized dealers.

Printing does not Start or Stops Halfway

- Is the printer door open?

"Close the printer door properly, and reset the printer." (☞ page 22)

- Is the printer connected to a computer?

Connect the printer to a computer correctly using a USB/LAN cable.

- Is the length of the USB cable too long?

A USB cable with a length of not more than 2 m is recommended.

- Are cards set into the printer?

"Set the cards correctly." (☞ page 31)

- Is the ink ribbon installed?

"Install the ink ribbon correctly." (☞ page 32)

- Is the retransfer film installed?

"Install the retransfer film correctly." (☞ page 33)

- Is the driver for this printer selected?

Select the driver for this printer.

Before Sending Printer for Repair

Enter the symptoms into the troubleshooting sheet.

- Clicking the Print icon displays a PDF file.
- Print out the PDF file and enter accordingly.

Installation and Connection

Printer Installation

Cautions:

- Using the printer in an environment beyond the operating ambient temperature range may result in retransfer or printing errors. Check the "Precautions on installation location" and "Operating environment conditions" specifications.

"Precautions on installation location" (page 6)

"Operating environment conditions" (page 10)

Ventilation holes for the cooling fan are located at the rear and side of the printer.

- Install the printer by allowing a clearance of at least 20 cm between its sides and surrounding walls.

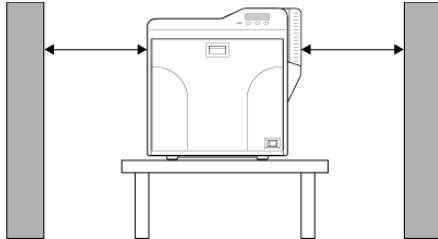

- Allow a clearance of at least 10 cm between the rear of the printer and the wall.

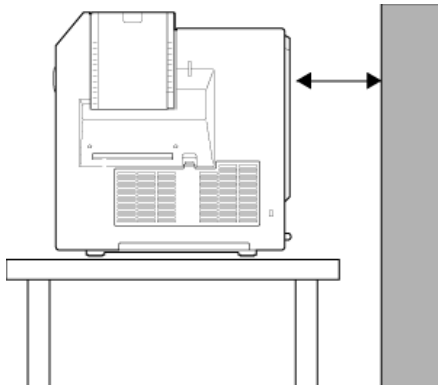

- Do not place any object on the printer.

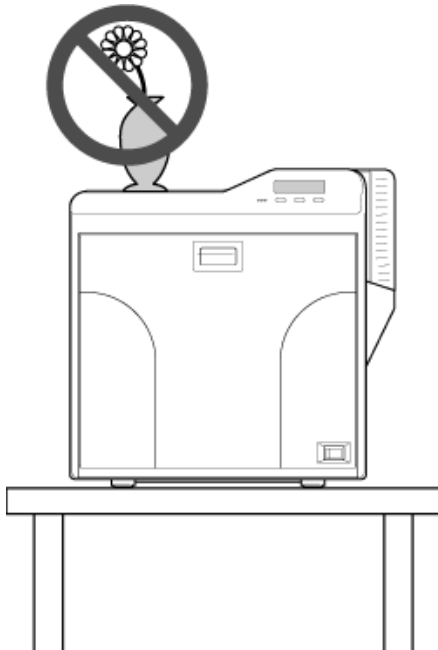

Power Cord Connection

- 1 Insert the power cord (supplied) to the AC inlet at the rear of the printer

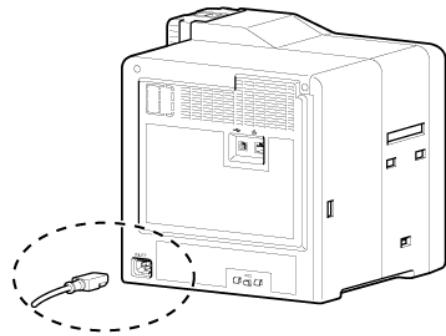

- 2 Plug the power cord (supplied) into an outlet

Memo:

- Make use of an AVR (automatic voltage regulator) to prevent any fluctuation in voltage. Alternatively, an uninterruptible power supply is recommended in case momentary power failure occurs.

Cautions:

- Make sure that the power outlet is grounded and used as a dedicated power source for the printer.
- Plug the power cord of the printer directly to the outlet. Do not share the same outlet with other devices.

Card Stacker (Supplied)

- 1 Hook the tab on the card stacker to the card stacker attachment slot

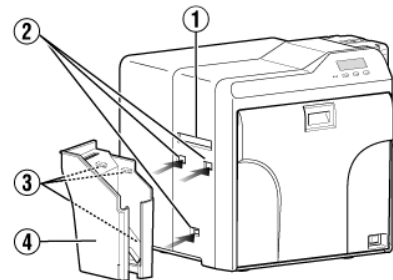

- 1 Card outlet
- 2 Card stacker attachment slot
- 3 Tab
- 4 Card stacker

Memo:

- The card stacker is able to store up to about 100 cards with a thickness of 0.76 mm.

Printing Media

Installing the Ink Ribbon

Cautions:

- Stand the cassette on a flat surface as illustrated in the diagram. Avoid doing so on the floor as dust attached to it may cause printing errors.

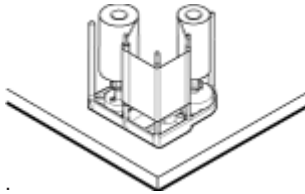

- Do not touch the inked surface (the side that faces outward when installed) with your hand. Touching it may cause printing errors. Put on the supplied gloves when handling the ink ribbon.
- The cassette is heavy when the ink ribbon is loaded. To prevent the cassette from dropping during handling, make sure to hold it with both hands.
- Do not perform any work on the printer door. Do not place heavy objects or apply load on the printer. Doing so may damage it.

1 Open the printer door



2 Press and hold down the cassette button, and remove the ink ribbon cassette (on the right)

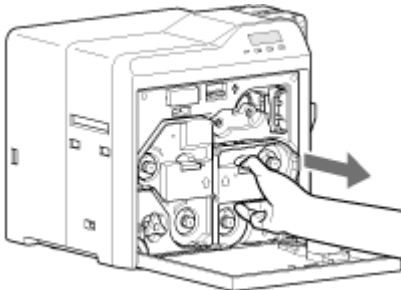

3 Install a new ink ribbon

- Install while referring to the indication on the label of the cassette.

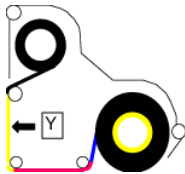

- With the inked surface facing outward, align the yellow side of the unused ribbon with the arrow on the cassette, and unwind it along the three shafts.
- Insert the ink ribbon firmly into the bobbin holders with the ribbon set to the far end of the guides.
 - A: take-up side (black)
 - B: unused side (yellow)

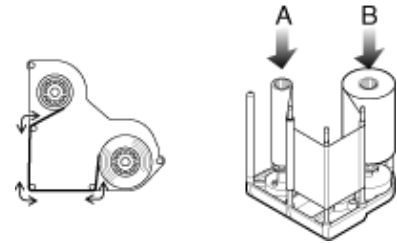

4 Remove any slack in the ink ribbon

- Hold the cassette.
- Turn the knob in the direction indicated by the arrow.

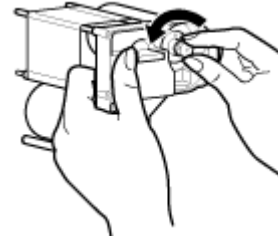

5 Insert the cassette all the way in along the guide rail until a "click" sound is heard, followed by closing the printer door

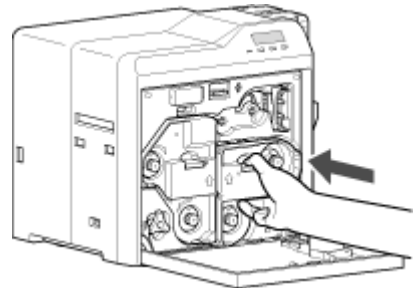
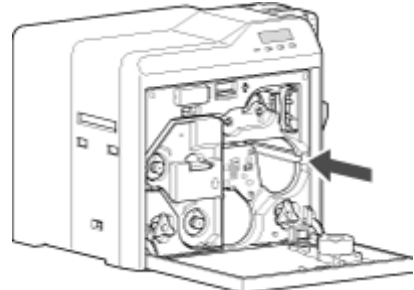

6 Press **Reset** to reset the printer

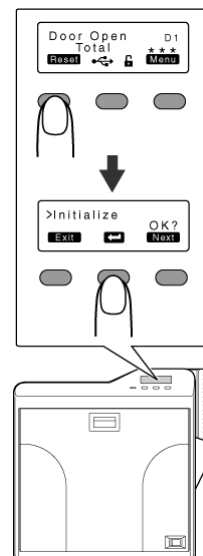

Memo:

- To avoid printing errors, it is recommended that you forward by one or two images after installing the ink ribbon cassette or retransfer film cassette. "Initializing printer when installing the cassette" (page 22)

Installing the Retransfer Film

Cautions:

- Stand the cassette on a flat surface as illustrated in the diagram. Avoid doing so on the floor as dust attached to it may cause printing errors.

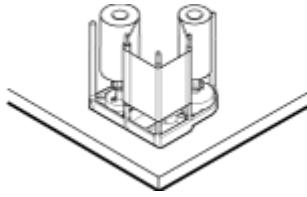

- Do not touch the retransfer face (the side that faces outward when installed) with your hand. Touching it may cause printing errors. Put on the supplied gloves when handling the retransfer film.
- The cassette is heavy when the retransfer film is loaded. To prevent the cassette from dropping during handling, make sure to hold it with both hands.
- When installing a new film, make sure that at least three black lines are wound onto the take-up side. Insufficient winding may cause the printer to malfunction.
- Do not perform any work on the printer door. Do not place heavy objects or apply load on the printer. Doing so may damage it.

1 Open the printer door



2 Press and hold down the cassette button, and remove the retransfer film cassette (on the left)

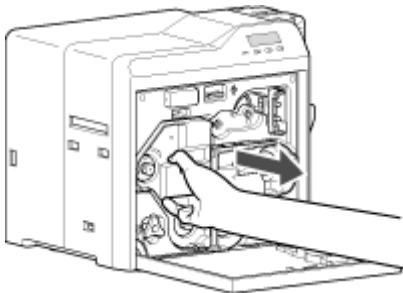

3 Install a new retransfer film

- Install while referring to the indication on the label of the cassette.
 - When installing the retransfer film, make sure that at least three black lines are wound onto the take-up side.

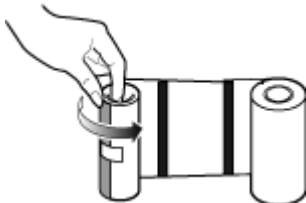

- With the retransfer face facing outward, align the unused side of the film with the arrow on the cassette, and unwind it along the three shafts.

- Insert the retransfer film firmly into the bobbin holders with the film set to the far end of the guides.

- A: take-up side (black)
- B: unused side (green)

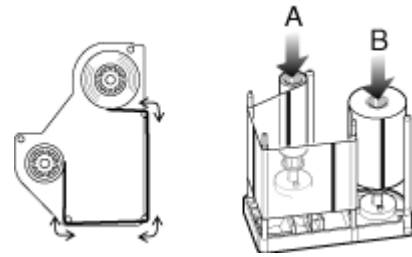

4 Remove any slack in the film

- Hold the retransfer film cassette.
- Turn the knob in the direction indicated by the arrow.



5 Insert the cassette all the way in along the guide rail until a "click" sound is heard, followed by closing the printer door

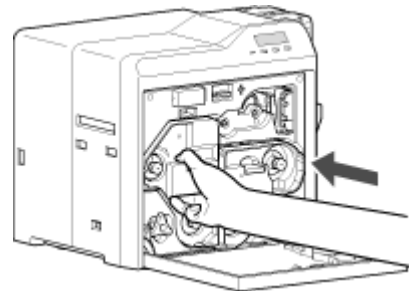
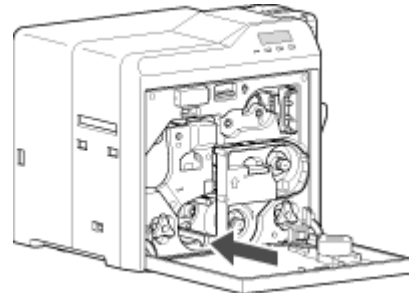

Cautions:

- While in the transport mode, the retransfer film cassette cannot be installed to the printer with the retransfer film loaded. With the printer door closed, turn on the power to cancel the transport mode.

"Transport Mode Setting" (page 29)

6 Press **Reset** →  to reset the printer

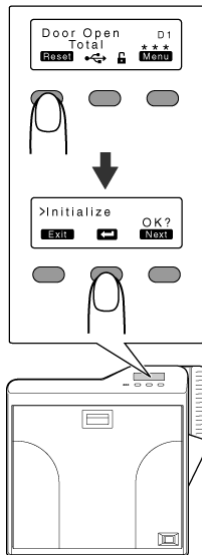

Memo:

- To avoid printing errors, it is recommended that you forward by one or two images after installing the ink ribbon cassette or retransfer film cassette.

"Initializing printer when installing the cassette" (☞ page 22)

Setting Cards

- The card hopper is able to store up to about 100 cards with a thickness of 0.76 mm.

Cautions:

- Get ready cards that are designated by the authorized dealer.
- If the security lock is on, deactivate it. After work is complete, activate the security lock again.
- Do not touch the printing surface of the card. Touching it may cause printing errors. Put on the supplied gloves when handling the cards.
- To prevent card jams from occurring, limit the number of cards stored in the card hopper at any time to about 100 pieces regardless of the card thickness.
- When using new cards, set them after making sure that they are not adhered to each other due to static.
- Align the cards before setting them in the printer. Otherwise, the card hopper cover may not close properly, and this may damage the printer.
- Printing the card on the side with the magnetic stripe may cause printing errors or damage to the card's functions. If you want to do so, please consult our authorized dealers in advance.
- To set cards with both functions (magnetic stripe and contact IC), follow the procedure for setting the contact IC card.

1 Set the card hopper knob to [OPEN]

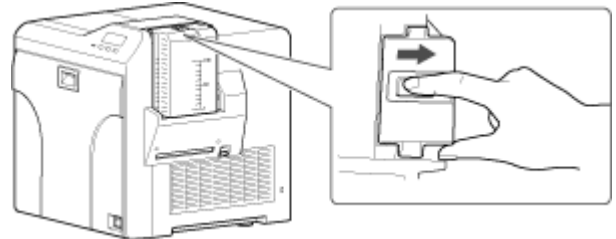

2 Lift to remove the card hopper cover

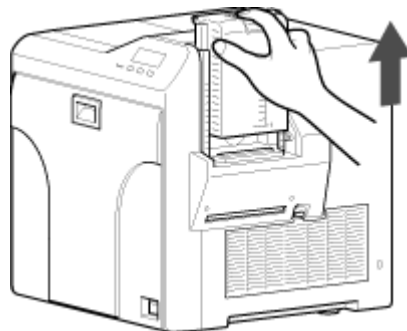

3 Align the orientation of the cards, and set them in the printer

■ Magnetic stripe cards

- Set the card with the magnetic stripe facing upward and toward the printer, or facing downward and toward you.

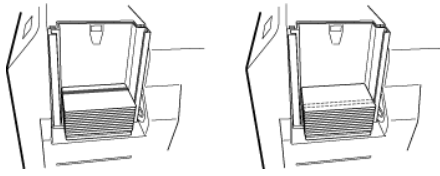

■ ISO contact IC cards

- Set the card with the Contact IC terminal facing upward and toward the rear of the printer, or downward and toward the rear of the printer.
- For single-sided printers, set the cards with the IC terminal facing down and toward the rear of the printer.

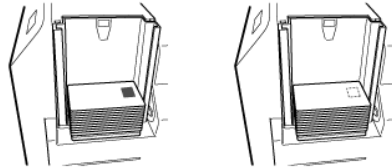

4 Install the card hopper cover, and set the card hopper knob to [LOCK]

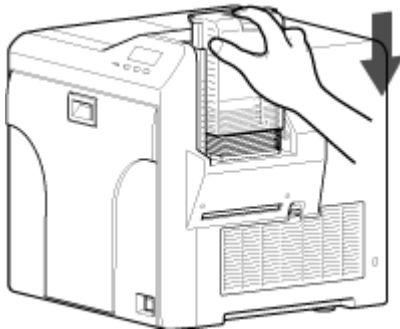

■ Adjusting card thickness

- The thickness of a card that is adjustable is between 0.25 mm and 1.00 mm. This is adjusted to a thickness of 0.76 mm by default.

① Set the card hopper knob to [LOCK]

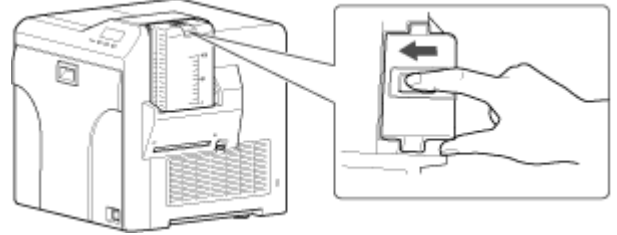

② Remove the card hopper

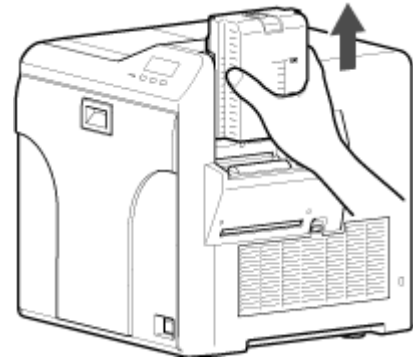

③ Insert a ballpoint pen into the card separator hole, and turn slowly

- Adjust according to the range of the card thickness used.

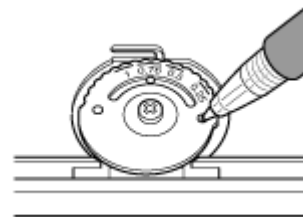

Memo:

- If the card cannot be discharged during printing, adjust the card thickness by turning the card separator in the clockwise direction by one scale at a time.
- If two cards are discharged at a time during printing, adjust the card thickness by turning the card separator in the anti-clockwise direction by one scale at a time.

④ Install the card hopper

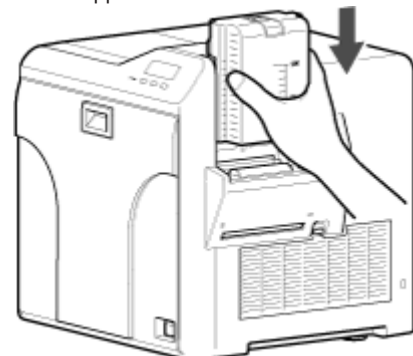

Printer and Computer Connection

Connecting with a USB Cable

Cautions:

- While printing is in progress, do not turn off the power of the computer, or switch it to the sleep or standby mode. Doing so may stop the movement of the cards inside the printer.
- Plug the USB cable in correctly and firmly.
- Do not connect the cable to the USB connectors on the monitor or keyboard of the computer. The printer may not be correctly recognized.
- When using a USB hub, make use of one that is directly connected to the computer.

1 Turn off the power of the printer and computer

2 Plug the USB cable into the USB cable connection terminal at the rear of the printer, and "Cable clamp" (see page 8) pass the USB cable through the cable clamp

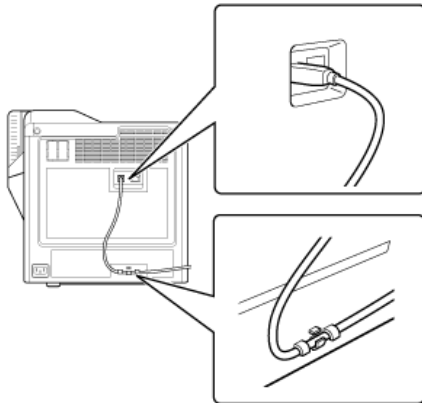

Cautions:

- As illustrated in the diagram, do not pull the USB cable excessively toward the cable clamp. Doing so may subject the USB connector of the printer to stress, thus resulting in connection problems.

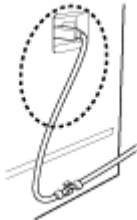

3 Plug the other end of the USB cable into the USB cable connection terminal of the computer

Connecting with a LAN Cable

Cautions:

- Plug the LAN cable in correctly and firmly.
- Make use of a shielded LAN cable to avoid any malfunction.
- If a USB cable is also connected at the same time when the power is turned on, priority will be given to USB.

1 Turn off the power of the printer and computer

2 Plug the LAN cable into the LAN cable connection terminal at the rear of the printer

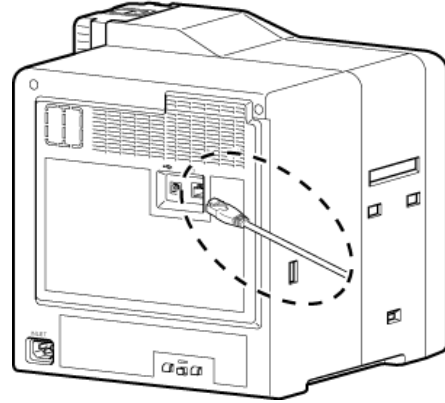

3 Plug the LAN cable into the connection terminal of the hub that is installed on the network that the computer is connected to

Connecting Multiple Printers

- To connect multiple printer units to one computer via USB, assign a different unit number from 1 to 10 to each of the printers.

"Unit Number Setting" (see page 28)

- To connect multiple printers to the same network, set a different IP address for each printer.

Computer Settings

■ System Requirements

- The printer software runs under the following environments.
- Microsoft Windows 8 32bit / 64bit
- Microsoft Windows 7 32bit / 64bit (First Release, Service Pack 1)
- Microsoft Windows Vista 32bit (Service Pack 1/2)
- Microsoft Windows XP 32bit (Service Pack 2/3)
- Microsoft Windows 2000 Professional 32bit (Service Pack 4)

- "Software" (page 65)
- "Install" (page 65)
- "Uninstall" (page 82)
- "IPSec" (page 87)
- "Printer Driver Settings" (page 90)
- "Port Monitor Settings" (page 110)
- "Status Monitor Settings" (page 111)
- "Inline Encoding" (page 123)
- "List of Error Codes" (page 125)
- "Frequently Asked Questions" (page 128)

Software

- Using the installer (automatic execution program) enables easy installation of the printer software, as well as opening of the Electronic Manual.
- The installer application installs programs based on the Windows language settings. To change the language setting of a program, use the language selection pull-down menu.

Software License Agreement

- Users need to agree to the terms and conditions in the "Software License Agreement" before using the software. Please read through the License Agreement.

Install

Cautions:

- To install the software, log into the system as an administrative user (Administrators group).
- A part of the illustrations in this Electronic Manual may not be displayed depending on the computer's environment. Skip the procedures in this case.

- "Printer Driver" (page 65)
- "Network Sharing of Printer" (page 73)
- "Status Monitor" (page 75)
- "USB Driver" (page 76)
- "Electronic Manual" (page 80)
- "Color Conversion Data" (page 81)

Printer Driver

Installing the Printer Driver

USB Connection

Cautions:

- Do not turn on the power of the printer until instruction asking you to do so appears on the installer.
- Do not connect the printer to the USB until instruction asking you to do so appears on the installer.
- You need to enable the USB hub before connecting the printer via this hub. Do not connect the printer to the USB hub until instruction asking you to do so appears.
- Exit all applications that are currently running.
- If document printing is currently in progress, wait for all the jobs to complete.

I Start up Windows, and set the supplied CD-ROM into the computer

- A card printer setup screen appears.

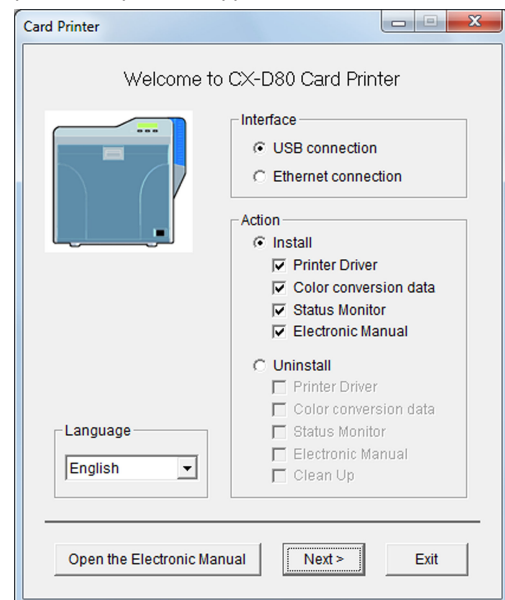

Memo:

- If the CD-ROM drive of the computer is set to run automatically, the installer will be executed automatically. If the installer is not automatically initiated, double-click "SETUP.exe" in the CD-ROM.
- If you are not using the "SETUP.exe" automatic execution program in the CD-ROM, start the installer for the printer driver by double-clicking the following file in the CD-ROM: "English\USB_Soft\install.exe".

■ **Windows Vista / Windows 7 / Windows 8**

- A [AutoPlay] screen appears.

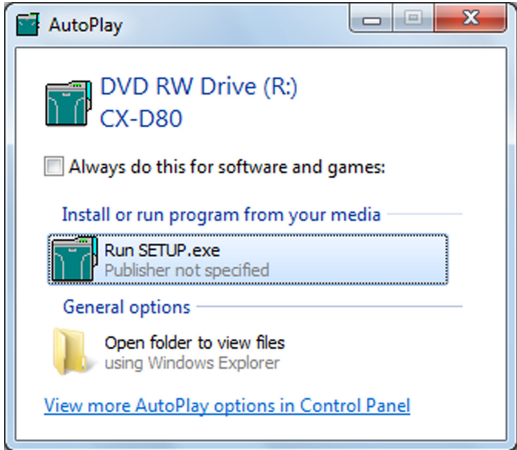

- Clicking [Run SETUP.exe] displays the [User Account Control] screen.
- Clicking [Yes] or [Allow] displays the card printer setup screen.

- 2 Select the [Printer Driver] checkbox on the card printer setup screen
 - ① Select the language to use from the [Language] pull-down menu
 - Selecting [Japanese] switches the program to the Japanese version.
 - Selecting [English] switches the program to the English version.
 - ② Select [USB connection] from [Interface]
 - ③ Select [Install] under [Action], and select the [Printer Driver] checkbox

Memo:

- You can select other checkboxes to install them simultaneously. Selecting all checkboxes starts installation in the order of the Electronic Manual, Printer Driver, Color Conversion Data and Status Monitor.
- The same status monitor can be used for printers connected via USB and Ethernet.

- Clicking [Open the Electronic Manual] opens the Electronic Manual.
- Clicking [Exit] ends the installation.

- 3 Click [Next]
 - A [Installation of CX-D80 USB printer] screen appears.

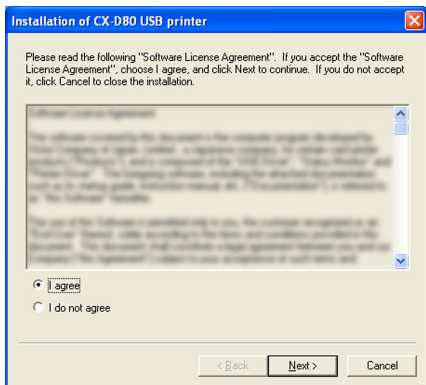

- 4 Read through the "Software License Agreement"
 - If you accept the terms and conditions, select [I agree] to start installation.
 - If you do not agree, click [Cancel] to stop the installation.

- 5 Click [Next]
 - A start installation screen appears.

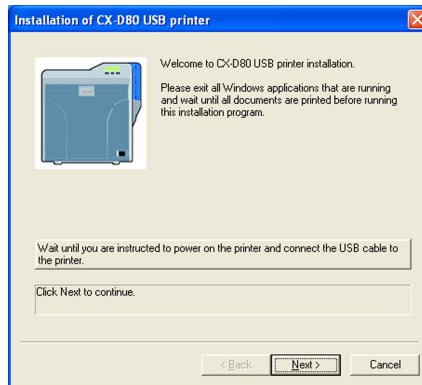

- 6 Check the details, followed by clicking [Next]
 - A screen for setting [Printer model] and [Printer name] appears.

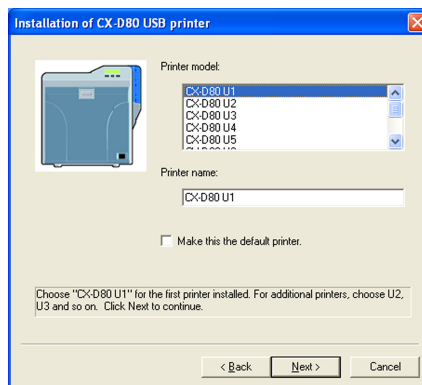

- ① Select a [Printer model] according to the unit number of the printer "Unit Number Setting" (☞ page 28)
 - Select a [Printer model] according to the unit number of the printer. Installation may fail if the combination is incorrect.

Printer Unit Number	Printer Model Options	USB Device Name
1 (Factory Setting)	CX-D80 U1	CX-D80 U1
2	CX-D80 U2	CX-D80 U2
3	CX-D80 U3	CX-D80 U3
4	CX-D80 U4	CX-D80 U4
5	CX-D80 U5	CX-D80 U5
6	CX-D80 U6	CX-D80 U6
7	CX-D80 U7	CX-D80 U7
8	CX-D80 U8	CX-D80 U8
9	CX-D80 U9	CX-D80 U9
10	CX-D80 U10	CX-D80 U10

- ② Enter the [Printer name]
- ③ Select the [Make this the default printer.] checkbox if necessary

Memo:

- Doing so enables you to set it as a default printer after installation is complete.

- 7 Click [Next]
 - A screen for entering the shared name appears.

- Enter the shared name when you are sharing a printer.

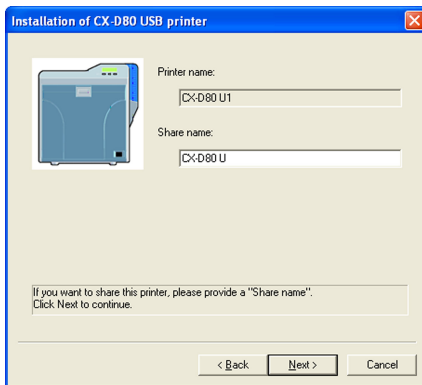

Memo:

- You can also set the shared name after installation is complete.

8 Click [Next]

- A port selection screen appears.
- Select [CX-D80U Port] under [Create a new port].

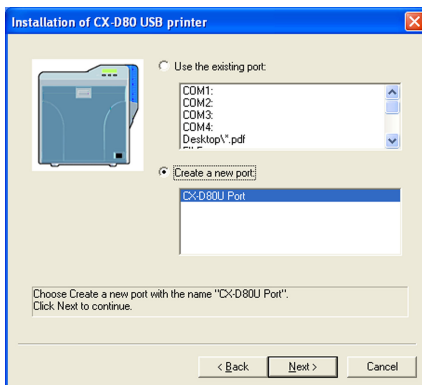

9 Click [Next]

- An install information confirmation screen appears.

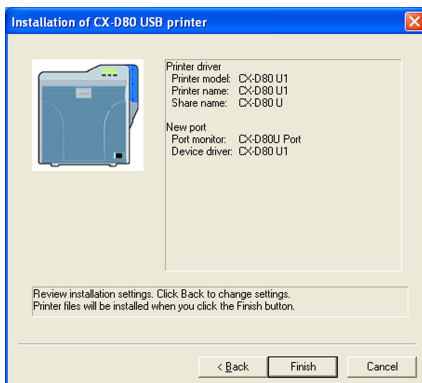

10 Check the installation information, followed by clicking [Finish]

- To change the settings, click [Back].

Windows XP

- A [Software Installation] screen appears.



- 1 Click [Continue Anyway]

Windows Vista / Windows 7 / Windows 8

- A [Windows Security] screen appears.

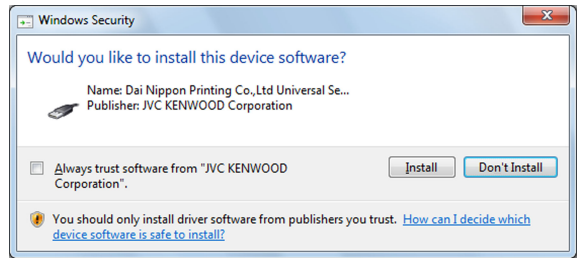

- 1 Click [Install]

- A USB cable connection instruction screen appears.

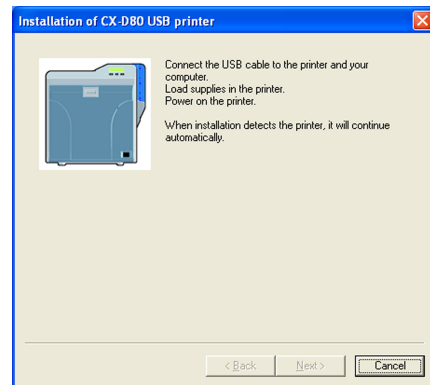

11 Connect the printer and computer using the USB cable

12 Turn on the power of the printer

- Installation starts automatically after the printer is detected.
- Installation does not start if connection is improper. When this occurs, check the connection.

Windows XP

- A [Found New Hardware Wizard] screen appears.



- 1 Select [No, not this time], and click [Next]

- An installation method selection screen appears.

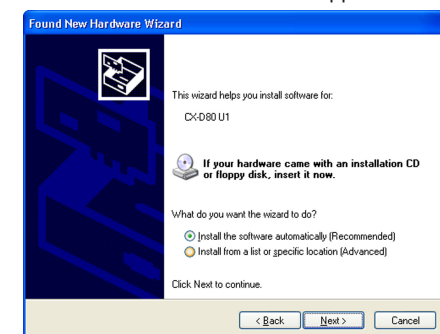

- ② Select [Install the software automatically (Recommended)], and click [Next]
- A [Hardware Installation] screen appears.



- ③ Click [Continue Anyway]
- A "Completing the Found New Hardware Wizard" screen appears.

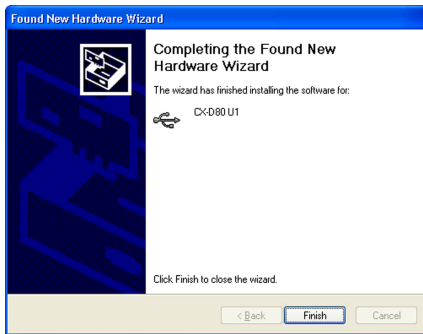

- ④ Click [Finish]
- A [Software Installation] screen appears.

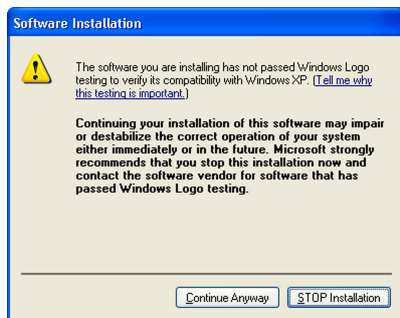

- ⑤ Click [Continue Anyway]

■ Windows Vista / Windows 7 / Windows 8

- A [Windows Security] screen appears.

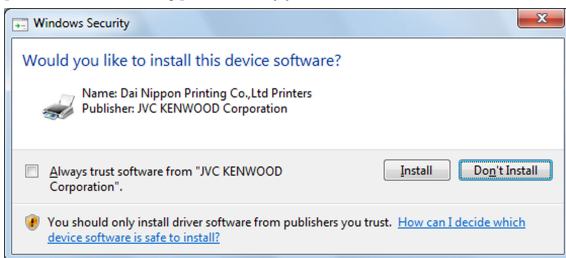

- ① Click [Install]

■ Windows 2000

- A [Digital Signature Not Found] screen appears.

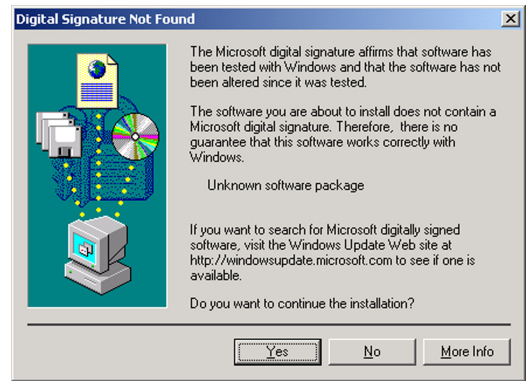

- ① Click [Yes]

- A [CX-D80U Port] screen appears.

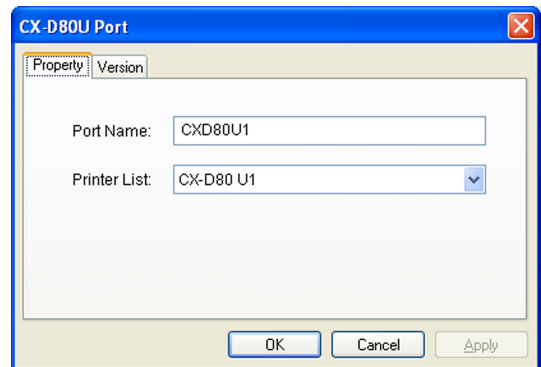

13 Select the [Property] tab

- ① Select this printer from [Printer List]

Memo:

- USB connection is improper if "No Device" appears in the [Printer List]. When this occurs, end the installation process and reinstall the program.
- If "No Selection" appears in the [Printer List], select a USB device name that coincides with the printer unit number that is currently being installed from the pull-down list.

- ② Enter the port name

14 Click [OK]

■ Windows XP

- A [Software Installation] screen appears.

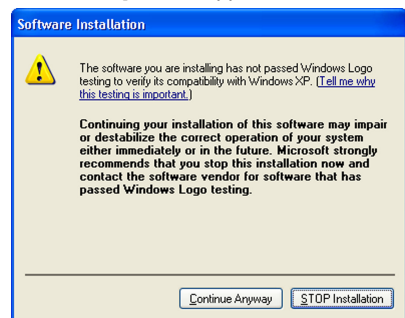

- ① Click [Continue Anyway]

■ Windows Vista / Windows 7 / Windows 8

- A [Windows Security] screen appears.

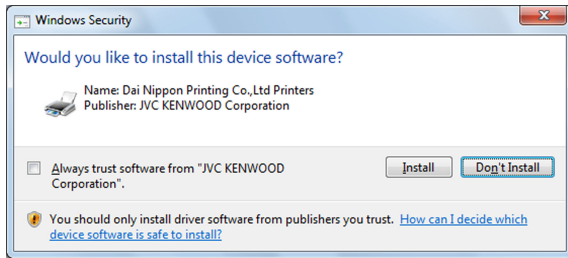

- 1 Click [Install]

■ Windows 2000

- A [Digital Signature Not Found] screen appears.

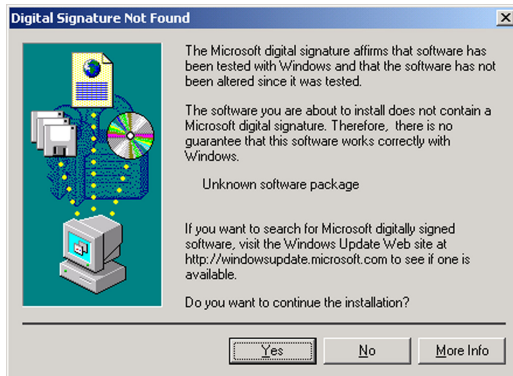

- 1 Click [Yes]

- A printer installation complete screen appears.

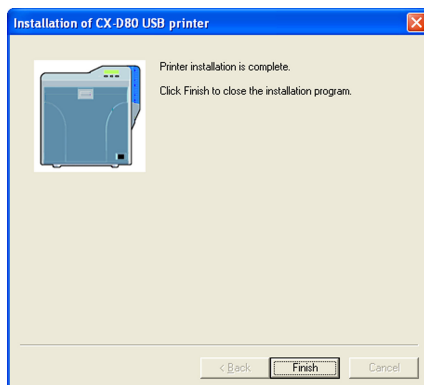

- 15 Click [Finish]

- Exits the installation program.

- 16 Open [Devices and Printers] or [Printers] in [Control Panel]

- Check to ensure that the printer is added.

■ Windows XP (Example)



■ Windows 7 (Example)

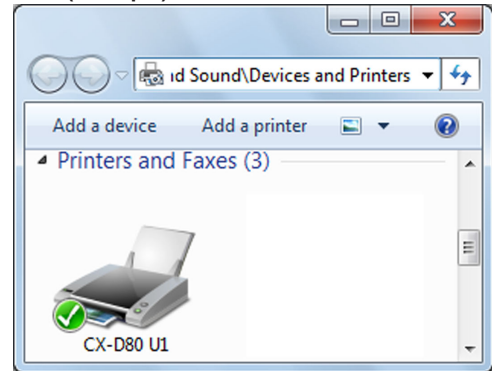

Cautions:

- To delete a printer, execute "Uninstall printer driver" after restarting Windows.

Ethernet (LAN) Connection

Cautions:

- Configure the IP address and other necessary settings for the printer in advance.
- Do not connect the printer to the USB port.
- Do not connect the printer to the Ethernet (LAN) until instruction asking you to do so appears on the installer.
- Do not turn on the power of the printer until instruction asking you to do so appears on the installer.
- You need to enable the LAN hub before connecting the printer via this hub.
- Exit all applications that are currently running.
- If document printing is currently in progress, wait for all the jobs to complete.

- 1 Start up Windows, and set the supplied CD-ROM into the computer

- A card printer setup screen appears.

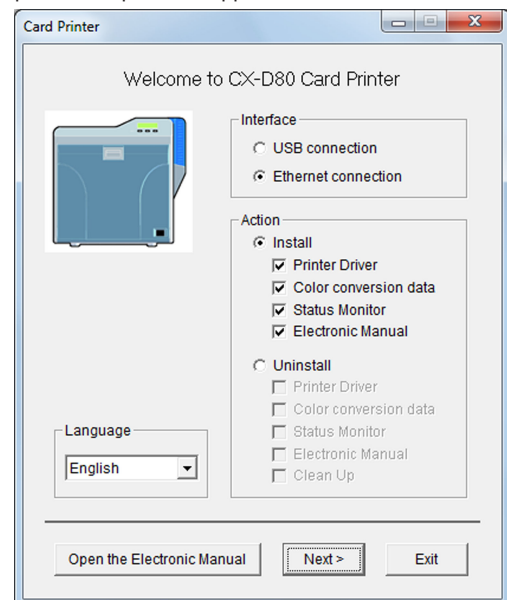

Memo:

- If the CD-ROM drive of the computer is set to run automatically, the installer will be executed automatically. If the installer is not automatically initiated, double-click "SETUP.exe" in the CD-ROM.
- If you are not using the "SETUP.exe" automatic execution program in the CD-ROM, start the installer for the printer driver by double-clicking the following file in the CD-ROM: "English\LAN_Soft\install.exe".

■ Windows Vista / Windows 7 / Windows 8

- A [AutoPlay] screen appears.



- Clicking [Run SETUP.exe] displays the [User Account Control] screen.
- Clicking [Yes] or [Allow] displays the card printer setup screen.

- 2 Select the [Printer Driver] checkbox on the card printer setup screen
 - ① Select the language to use from the [Language] pull-down menu
 - Selecting [Japanese] switches the program to the Japanese version.
 - Selecting [English] switches the program to the English version.
 - ② Select [Ethernet connection] from [Interface].
 - ③ Select [Install] under [Action], and select the [Printer Driver] checkbox

Memo:

- You can select other checkboxes to install them simultaneously. Selecting all checkboxes starts installation in the order of the Electronic Manual, Status Monitor, Printer Driver and Color Conversion Data.
- The same status monitor can be used for printers connected via USB and Ethernet.

- Clicking [Open the Electronic Manual] opens the Electronic Manual.
- Clicking [Exit] ends the installation.

- 3 Click [Next]
 - A [Installation of CX-D80 Ethernet printer] screen appears.

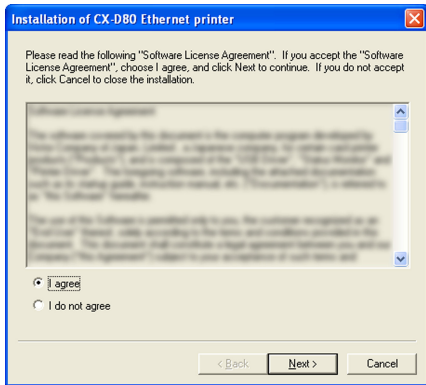

- 4 Read through the "Software License Agreement"
 - If you accept the terms and conditions, select [I agree] to start installation.
 - If you do not agree, click [Cancel] to stop the installation.

- 5 Click [Next]
 - A start installation screen appears.

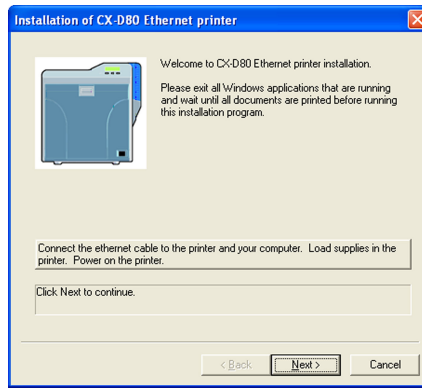

- 6 Connect the printer and computer using a LAN cable
- 7 Turn on the power of the printer
- 8 Check the details, followed by clicking [Next]
 - A screen for setting [Printer model] and [Printer name] appears.

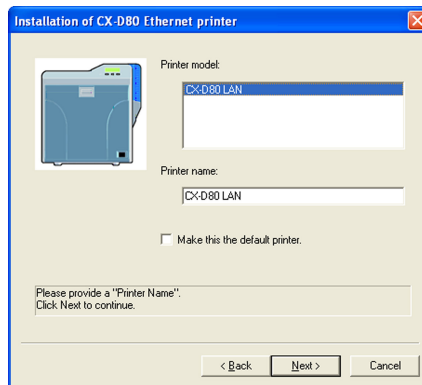

- ① Select a [Printer model]
- ② Enter the [Printer name]
- ③ Select the [Make this the default printer.] checkbox if necessary

Memo:

- Doing so enables you to set it as a default printer after installation is complete.

- 9 Click [Next]
 - A screen for entering the shared name appears.
 - Enter the shared name when you are sharing a printer.

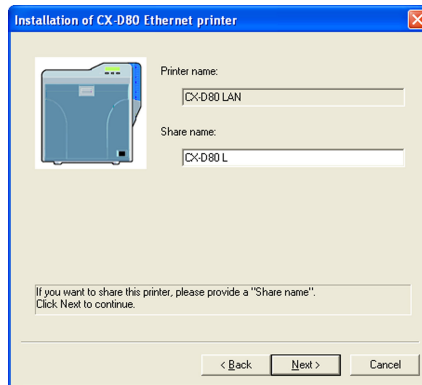

Memo:

- You can also set the shared name after installation is complete.

10 Click [Next]

- A port selection screen appears.
- Select [CX-D80N Port] under [Create a new port].

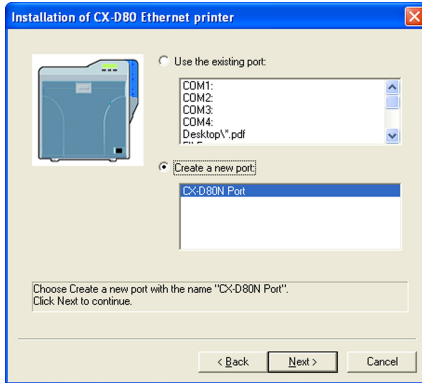

11 Click [Next]

- An install information confirmation screen appears.

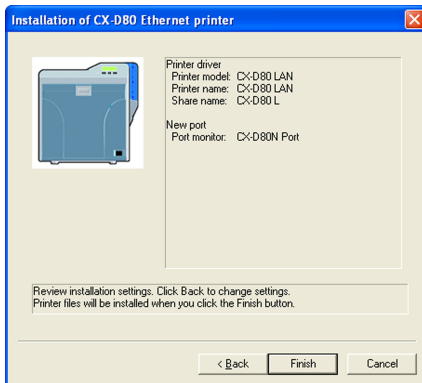

12 Check the installation information, followed by clicking [Finish]

- To change the settings, click [Back].

■ Windows XP

- A [Software Installation] screen appears.

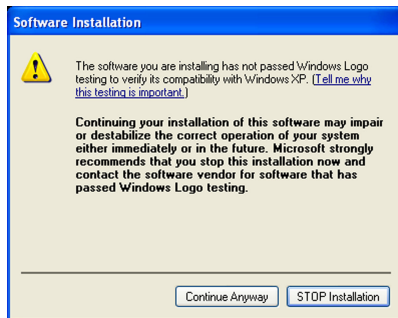

① Click [Continue Anyway]

- A [Windows Security Alert] screen appears.



② Click [Unblock]

- The program will fail to function properly if you click on buttons other than [Unblock].

■ Windows Vista / Windows 7 / Windows 8

- A [Windows Security] screen appears.

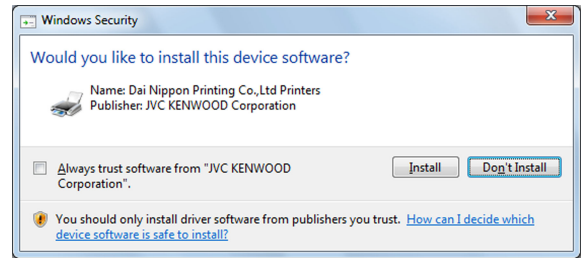

① Click [Install]

- A [Windows Security Alert] screen appears.

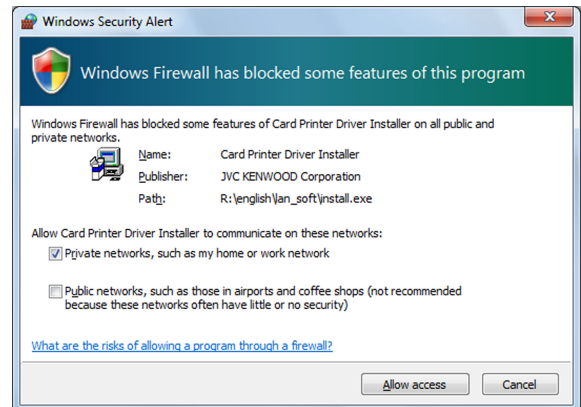

② Click [Allow access] or [Unblock]

- The program will fail to function properly if you click on [Cancel] or [Keep blocking].

- A [CX-D80N Port] screen appears.

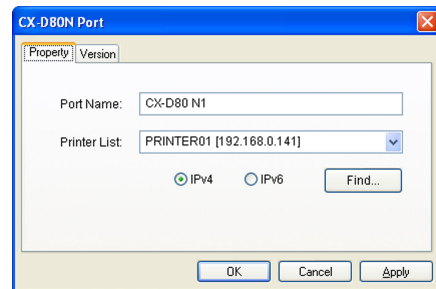

13 Select the [Property] tab

① Select this printer from [Printer List]

- When connecting using the IPv4 address, select [IPv4], followed by clicking [Find...], you can search for the printer by directly entering the IPv4 address in the [Printer List].
- When connecting using the IPv6 address, select [IPv6], followed by clicking [Find...], you can search for the printer by directly entering the IPv6 address in the [Printer List].

Memo:

- Ethernet (LAN) connection is improper if "Not Connected" appears in the [Printer List]. If the printer that is currently being installed cannot be found by clicking [Find...], end the installation process and reinstall the program.
- If "Not Selected" appears in the [Printer List], select an item that coincides with the IP address of the printer that is currently being installed from the pull-down list.

② Enter the [Port Name]

14 Click [OK]

■ Windows XP

- A [Software Installation] screen appears.



- 1 Click [Continue Anyway]

■ Windows Vista / Windows 7 / Windows 8

- A [Windows Security] screen appears.

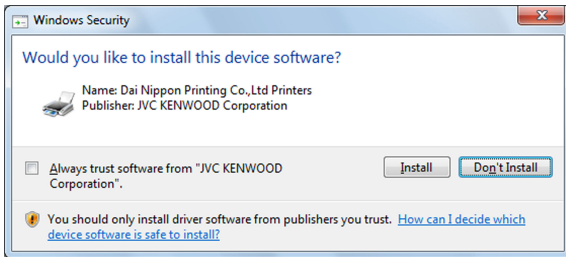

- 1 Click [Install]

■ Windows 2000

- A [Digital Signature Not Found] screen appears.

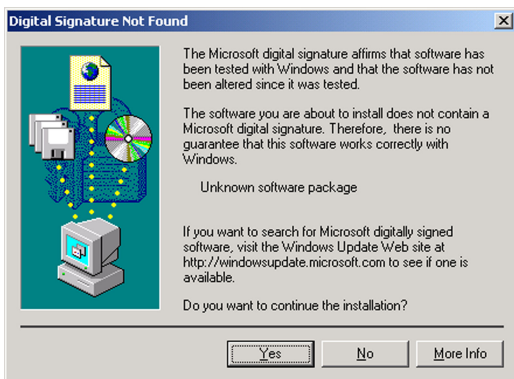

- 1 Click [Yes]

- A printer installation complete screen appears.

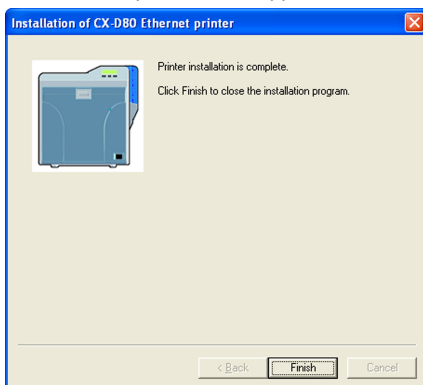

15 Click [Finish]

- Exits the installation program.

16 Open [Devices and Printers] or [Printers] in [Control Panel]

- Check to ensure that the printer is added.

■ Windows XP (Example)



■ Windows 7 (Example)

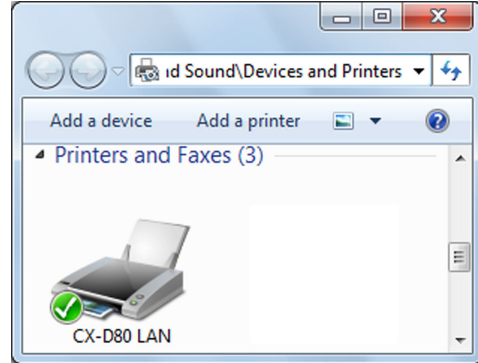

Cautions:

- To delete a printer, execute "Uninstall printer driver" after restarting Windows.

Update of Printer Driver

To update

- 1 Delete the existing printer driver
"Uninstalling the Printer Driver" (☞ page 82)
- 2 Re-install the printer driver
"Installing the Printer Driver" (☞ page 65)

Network Sharing of Printer

Windows XP / Windows 2000

Cautions:

- Check to ensure that you can access the computer to which the printer is connected.
- Check also to ensure that the printer can be shared.

1 Open "Printers" in [Control Panel]

- A [Printers and Faxes] screen appears.

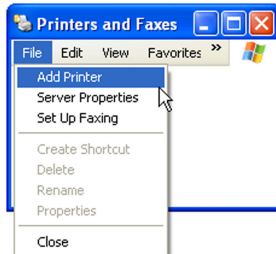

2 Click [Add Printer] under the [File] menu

- A "Welcome to the Add Printer Wizard" screen appears.

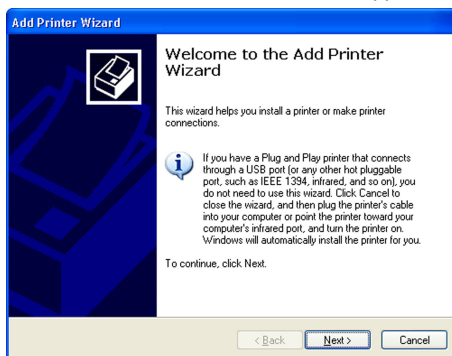

3 Click [Next]

- A printer type selection screen appears.

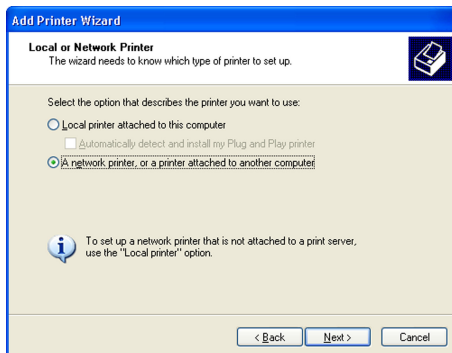

4 Select [A network printer, or a printer attached to another computer], and click [Next]

- A "Specify a Printer" screen appears.

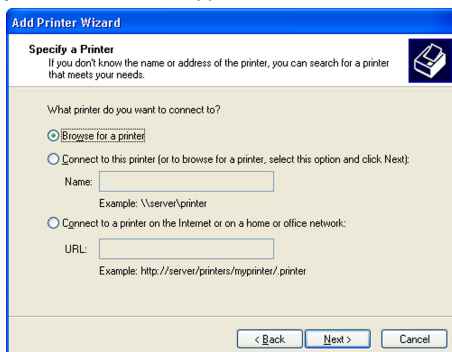

5 Select [Browse for a printer], and click [Next]

- A "Browse for Printer" screen appears.

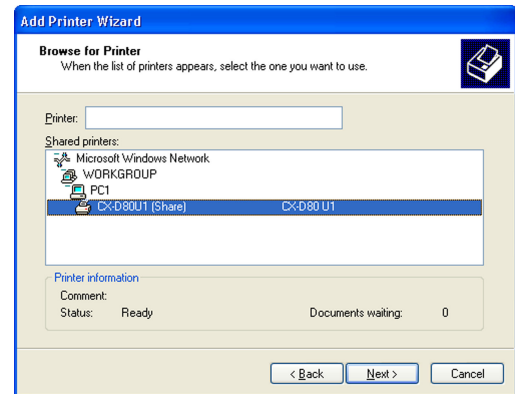

6 Select a printer from [Shared printers], and click [Next]

- A [Connect to Printer] screen appears.

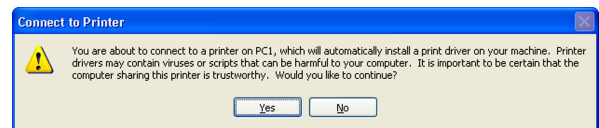

7 Click [Yes]

- A "Default Printer" screen appears.

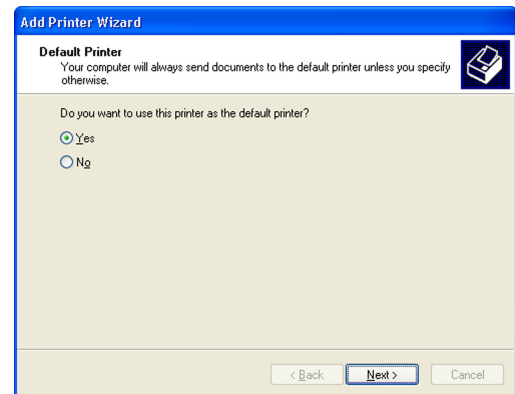

8 Select [Yes] if necessary, and click [Next]

- A "Completing the Add Printer Wizard" screen appears.

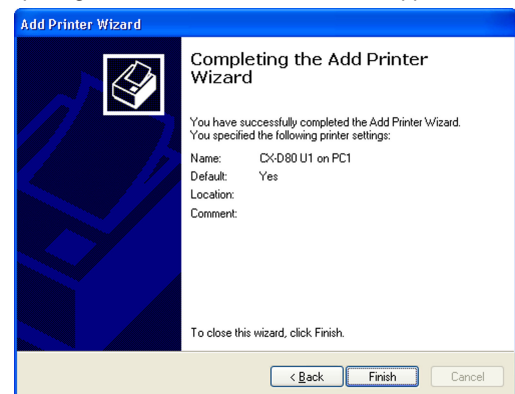

9 Check the details, followed by clicking [Finish]

- Network sharing of the printer is complete.

10 Open "Printers" in [Control Panel]

- Check to ensure that the printer is added.



Cautions:

- When the access authority of the computer is not proper, the printer may not be able to perform printing even if installation of the printer driver is completed.
Ensure that the access authority is proper according to the instructions of the network administrator.

Windows Vista / Windows 7 / Windows 8

Cautions:

- Check to ensure that you can access the computer to which the printer is connected.
- Check also to ensure that the printer can be shared.

1 Open [Devices and Printers] or [Printers] in [Control Panel]

- A [Printer] screen appears.

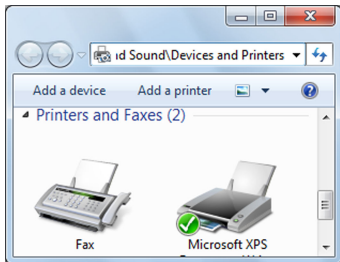

2 Click [Add a printer] in the toolbar

- A printer selection screen appears.

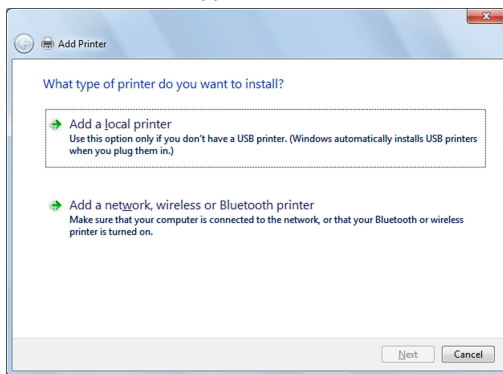

3 Select [Add a network, wireless or Bluetooth printer], and click [Next]

- A screen for selecting the printer appears.

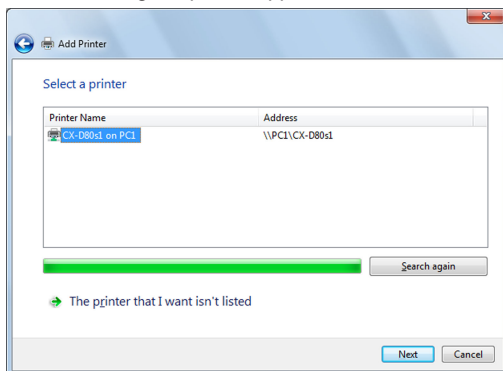

4 Select a printer, and click [Next]

- A driver installation confirmation screen appears.

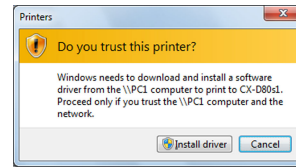

5 Click [Install driver]

- A [User Account Control] screen appears.

6 On the user account screen, click [Continue]

- A screen indicating that the printer is added appears.

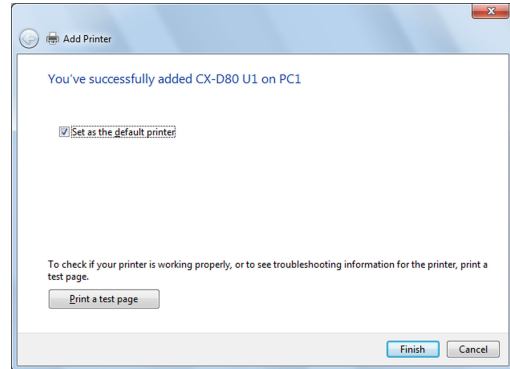

7 Select the [Set as the default printer] checkbox if necessary, and click [Finish]

- Network sharing of the printer is complete.

8 Open [Devices and Printers] or [Printers] in [Control Panel]

- Check to ensure that the printer is added.

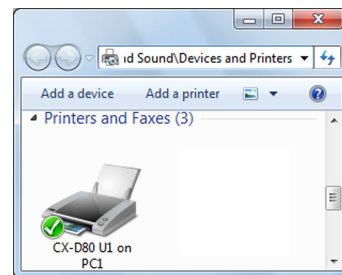

Cautions:

- When the access authority of the computer is not proper, the printer may not be able to perform printing even if installation of the printer driver is completed.
Ensure that the access authority is proper according to the instructions of the network administrator.

Status Monitor

Installing the Status Monitor

Cautions:

- The same status monitor can be used for printers connected via USB and Ethernet.
- Make sure that the status monitor is only installed once on a single computer.
- To continue using the status monitor after uninstalling the printer driver, update the status monitor accordingly.

"Update of Status Monitor" (page 76)

- 1 Start up Windows, and set the supplied CD-ROM into the computer
- A card printer setup screen appears.

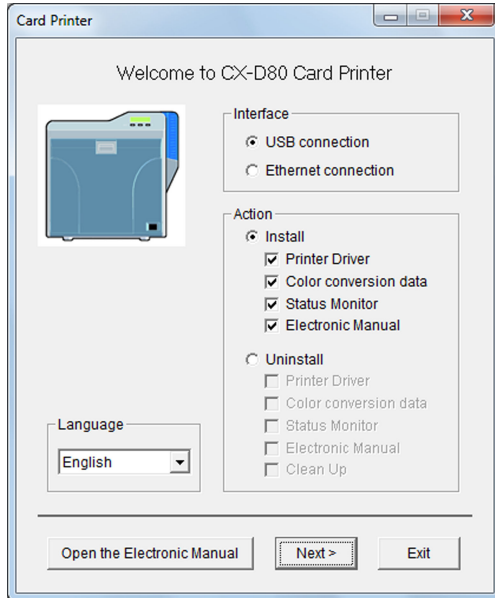

Memo:

- If the CD-ROM drive of the computer is set to run automatically, the installer will be executed automatically. If the installer is not automatically initiated, double-click "SETUP.exe" in the CD-ROM.
- If you are not using the "SETUP.exe" automatic execution program in the CD-ROM, start the installer for the status monitor by double-clicking the following file in the CD-ROM: "English\Software\STT_MON\install.exe".

■ Windows Vista / Windows 7 / Windows 8

- A [AutoPlay] screen appears.

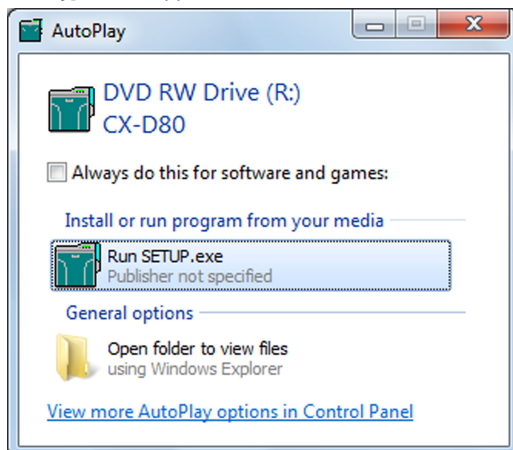

- Clicking [Run SETUP.exe] displays the [User Account Control] screen.
- Clicking [Yes] or [Allow] displays the card printer setup screen.

- 2 Select the [Status Monitor] checkbox on the card printer setup screen

- ① Select the language to use from the [Language] pull-down menu
 - Selecting [Japanese] switches the program to the Japanese version.
 - Selecting [English] switches the program to the English version.
- ② Select [USB connection] or [Ethernet connection] from [Interface]
- ③ Select [Install] under [Action], and select the [Status Monitor] checkbox

Memo:

- You can select other checkboxes to install them simultaneously.

- Clicking [Open the Electronic Manual] opens the Electronic Manual.
- Clicking [Exit] ends the installation.

- 3 Click [Next]

- A status monitor installation screen appears.

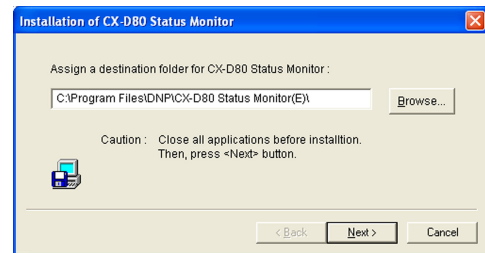

- To change the displayed installation destination, click [Browse...] and specify the destination folder.

- 4 Click [Next]

- A selection screen for registering the status monitor appears.

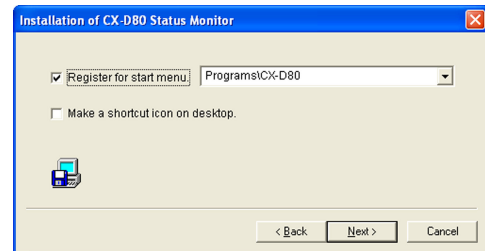

- ① Select the [Register for start menu] checkbox
 - To change the registration in the displayed Start menu, make a selection from the [Register for start menu] list.
- ② Select the [Make a shortcut icon on desktop.] checkbox if necessary

- 5 Click [Next]

- Installation starts.

- After installation is complete, an installation complete screen appears.

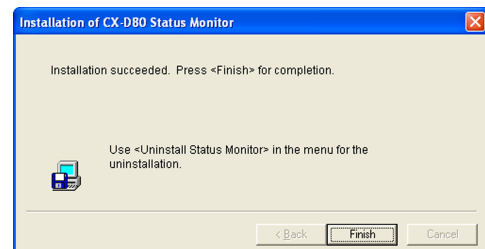

- 6 Click [Finish]

- An installation complete confirmation screen appears.

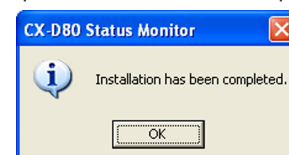

Setup

7 Click [OK]

- Exits the installation program.
- You can now start the status monitor from [Start menu].

Cautions:

- The following error may occur when you start executing the status monitor.

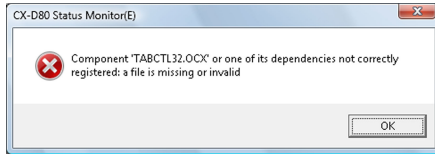

Cause: The status monitor cannot run because the program cannot be identified by Windows.

Action: Select "Run as administrator" to start the status monitor as a user with administrator authority. Doing so enables the program to be identified by Windows, and the same error will not recur.

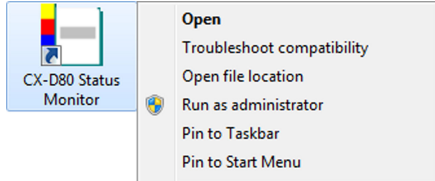

- Even if a user is logged on with the administrator account, the user may be regarded as one without administrator authority when running the status monitor.

Update of Status Monitor

1 Delete the status monitor

"Uninstalling the Status Monitor" (☞ page 85)

2 Re-install the status monitor

"Installing the Status Monitor" (☞ page 75)

USB Driver

Installing the USB Driver

Cautions:

- The USB driver is also installed while you are installing the printer driver via USB connection.
- Install the USB driver additionally only when you want to set items other than the [Printer Name] on the [Printer Selection] screen of the status monitor.
- Do not turn on the power of the printer until instruction asking you to do so appears on the installer.
- Do not connect the printer to the USB until instruction asking you to do so appears on the installer.
- You need to enable the USB hub before connecting the printer via this hub. Do not connect the printer to the USB hub until instruction asking you to do so appears.

Windows XP

1 Start up Windows

2 Set the supplied CD-ROM into the computer

- The "SETUP.exe" automatic execution program in the CD-ROM is not used. Exit this program.

3 Connect the computer and printer using the USB cable, and turn on the power of the printer

- The printer is automatically detected by the computer.
- A [Found New Hardware Wizard] screen appears.



Cautions:

- Connection is improper if this screen does not appear. Make sure that the connection is properly established.

4 Select [No, not this time], and click [Next]

- An installation method selection screen appears.

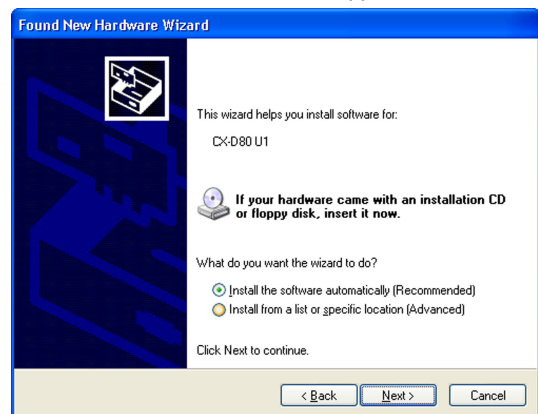

5 Select [Install the software automatically (Recommended)], and click [Next]

- A [Hardware Installation] screen appears.



6 Click [Continue Anyway]

- A "Completing the Found New Hardware Wizard" screen appears.

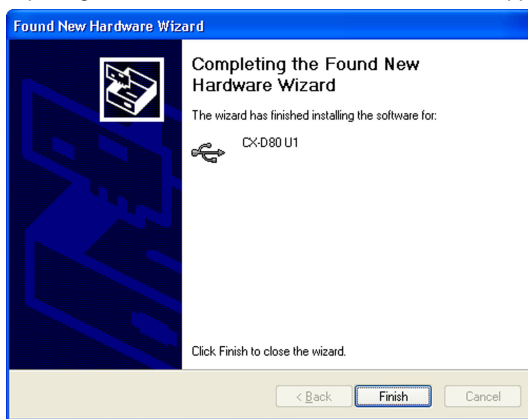

7 Click [Finish]

- Installation of the USB driver is complete.

Windows Vista

1 Start up Windows

2 Connect the computer and printer using the USB cable, and turn on the power of the printer

- The printer is automatically detected by the computer.
- A [Found New Hardware] screen appears.

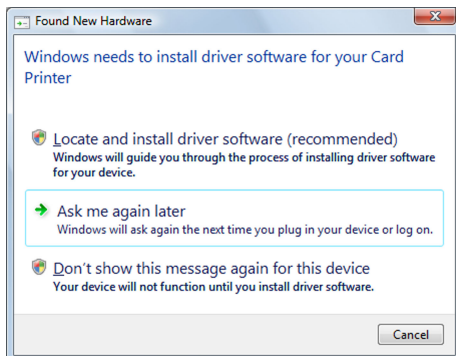

Cautions:

- Connection is improper if this screen does not appear. Make sure that the connection is properly established.

3 Click [Locate and install driver software (Recommended)]

- A [User Account Control] screen appears.

4 Click [Continue]

- A [Found New Hardware] screen appears.

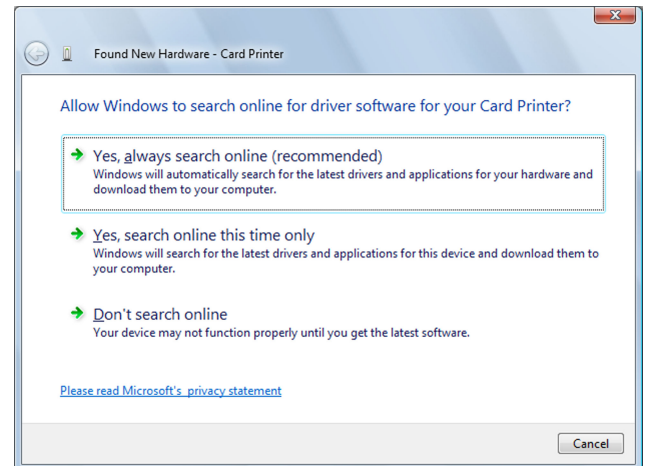

5 Click [Don't search online]

- A screen appears, prompting you to insert the disc.

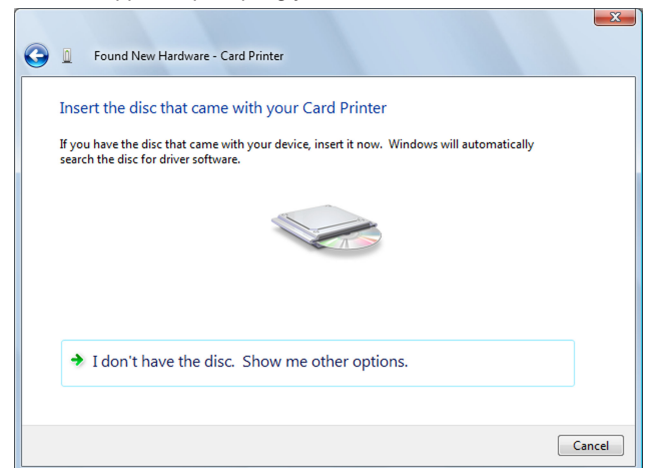

6 Set the supplied CD-ROM into the computer

- The "SETUP.exe" automatic execution program in the CD-ROM is not used. Exit this program.
- A [Windows Security] screen appears.

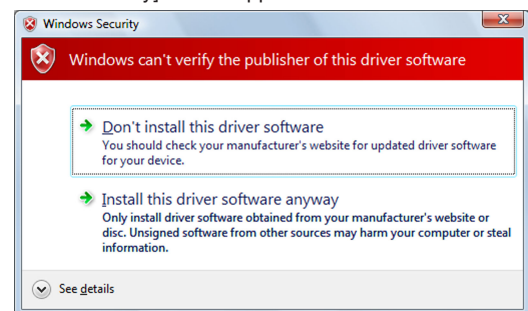

Setup

7 Click [Install this driver software anyway]

- An installation complete screen appears.

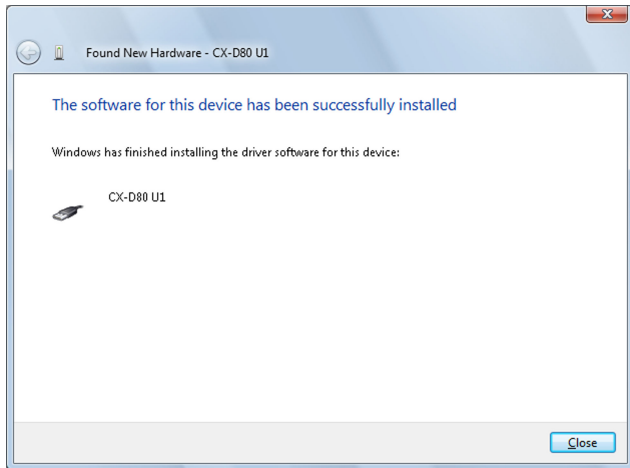

8 Click [Close]

- Installation of the USB driver is complete.

Windows 7 / Windows 8

1 Start up Windows

2 Set the supplied CD-ROM into the computer

- The "SETUP.exe" automatic execution program in the CD-ROM is not used. Exit this program.

3 Connect the computer and printer using the USB cable, and turn on the power of the printer

- The printer is automatically detected by the computer.

4 Open [Device Manager] in [Control Panel]

- Check to ensure that a [Card Printer] is found in the [Other devices].

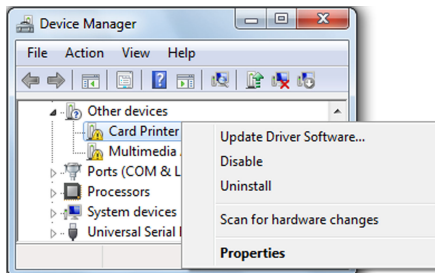

5 Click [Update Driver Software...] under a [Card Printer] menu

- An [Update Driver Software] screen appears.

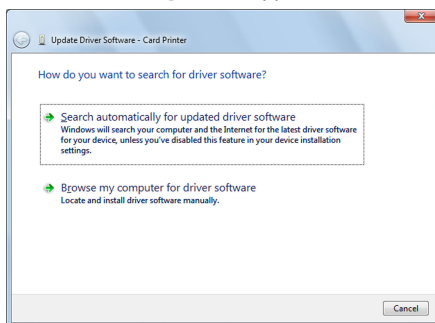

6 Click [Browse my computer for driver software]

- A [Browse for driver software on your computer] screen appears.

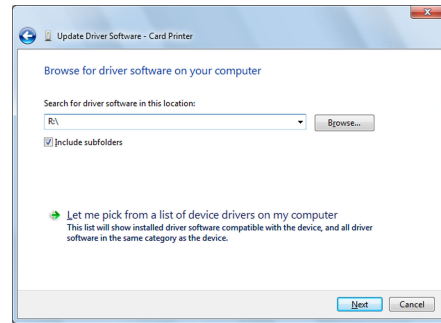

① Select the CD-ROM in the [Search for driver software on this location:]

② Select a [include subfolders]

7 Click [Next]

- A [Windows Security] screen appears.

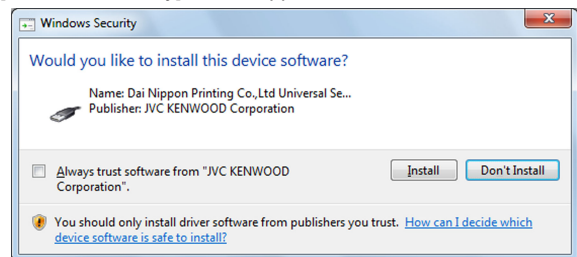

8 Click [Install]

- An installation complete screen appears.

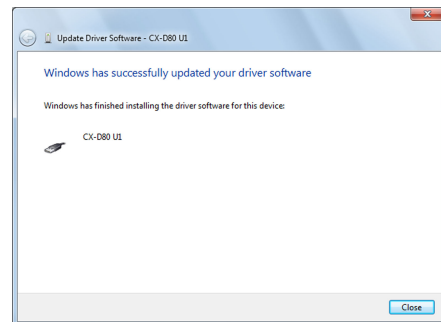

9 Click [Close]

- Installation of the USB driver is complete.

Windows 2000

- 1 Start up Windows
- 2 Set the supplied CD-ROM into the computer
 - The “SETUP.exe” automatic execution program in the CD-ROM is not used. Exit this program.
- 3 Connect the computer and printer using the USB cable, and turn on the power of the printer
 - The printer is automatically detected by the computer.
 - A [Found New Hardware Wizard] screen appears.



Cautions:

- Connection is improper if this screen does not appear. Make sure that the connection is properly established.

4 Click [Next]

- A search method selection screen appears.



5 Select [Search for a suitable driver for my device (recommended)], and click [Next]

- A “Locate Driver Files” screen appears.

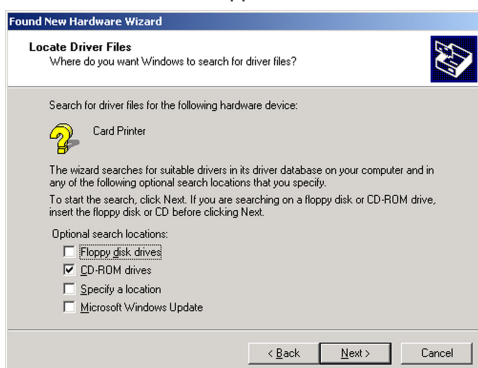

6 Select the [CD-ROM drives] checkbox, and click [Next]

- A “Driver Files Search Results” screen appears.

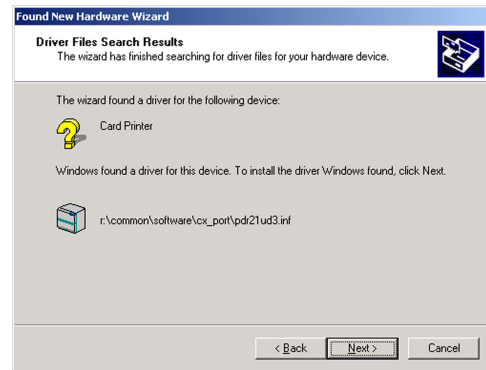

7 Click [Next]

- A “Completing the Found New Hardware Wizard” screen appears.



8 Click [Finish]

- Installation of the USB driver is complete.

Electronic Manual

Installing the Electronic Manual

- 1 Start up Windows, and set the supplied CD-ROM into the computer
- A card printer setup screen appears.



Memo:

- If the CD-ROM drive of the computer is set to run automatically, the installer will be executed automatically. If the installer is not automatically initiated, double-click "SETUP.exe" in the CD-ROM.
- If you are not using the "SETUP.exe" automatic execution program in the CD-ROM, start the installer for the Electronic Manual by double-clicking the following file in the CD-ROM: "English\Document \Manual\install.exe".

Windows Vista / Windows 7 / Windows 8

- A [AutoPlay] screen appears.

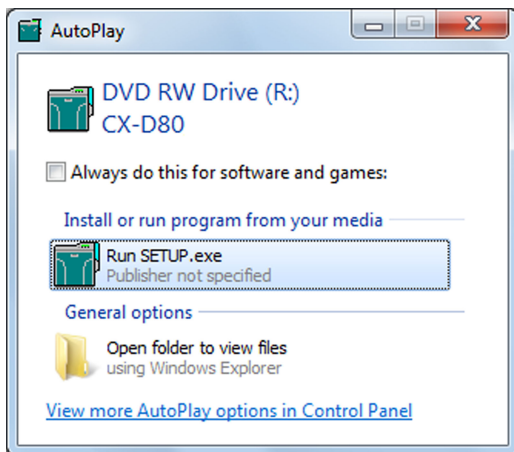

- Clicking [Run SETUP.exe] displays the [User Account Control] screen.
- Clicking [Yes] or [Allow] displays the card printer setup screen.

- 2 Select the [Electronic Manual] checkbox on the card printer setup screen
 - 1 Select the language to use from the [Language] pull-down menu
 - Selecting [Japanese] switches the program to the Japanese version.
 - Selecting [English] switches the program to the English version.
 - 2 Select [USB connection] or [Ethernet connection] from [Interface]
 - 3 Select [Install] under [Action], and select the [Electronic Manual] checkbox

Memo:

- You can select other checkboxes to install them simultaneously.
- Clicking [Open the Electronic Manual] opens the Electronic Manual.
 - Clicking [Exit] ends the installation.

- 3 Click [Next]
 - An Electronic Manual installation screen appears.

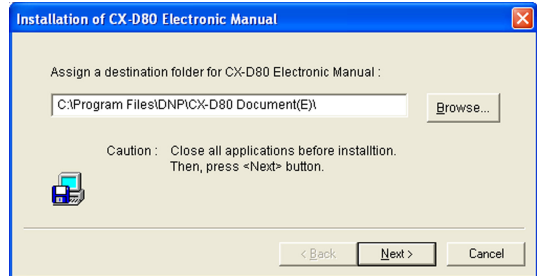

- To change the displayed installation destination, click [Browse...] and specify the destination folder.

- 4 Click [Next]
 - A selection screen for registering the Electronic Manual appears.

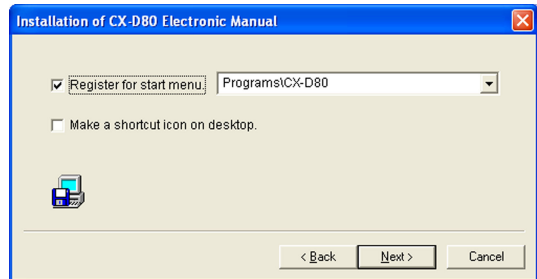

- 1 Select the [Register for start menu] checkbox
 - To change the registration in the displayed Start menu, make a selection from the [Register for start menu] list.
- 2 Select the [Make a shortcut icon on desktop.] checkbox if necessary

- 5 Click [Next]
 - Installation starts.
 - After installation is complete, an installation complete screen appears.

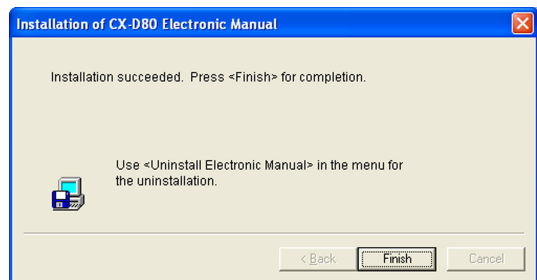

- 6 Click [Finish]
 - An installation complete confirmation screen appears.

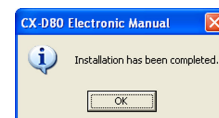

- 7 Click [OK]
 - Exits the installation program.
 - You can now open the Electronic Manual from [Start menu].

Color Conversion Data

Installing the Color Conversion Data

- 1 Start up Windows, and set the supplied CD-ROM into the computer
- A card printer setup screen appears.



Memo:

- If the CD-ROM drive of the computer is set to run automatically, the installer will be executed automatically.
If the installer is not automatically initiated, double-click "SETUP.exe" in the CD-ROM.
- If you are not using the "SETUP.exe" automatic execution program in the CD-ROM, start the installer for the Color Conversion Data by double-clicking the following file in the CD-ROM: "CommonData \LUT24\install.exe".

■ Windows Vista / Windows 7 / Windows 8

- A [AutoPlay] screen appears.

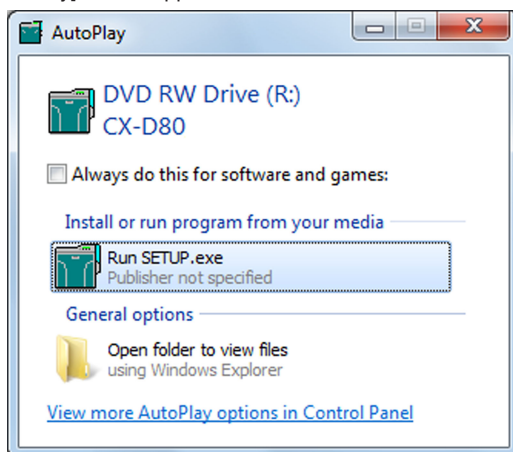

- Clicking [Run SETUP.exe] displays the [User Account Control] screen.
- Clicking [Yes] or [Allow] displays the card printer setup screen.

- 2 Select the [Color Conversion Data] checkbox on the card printer setup screen
 - ① Select the language to use from the [Language] pull-down menu
 - Selecting [Japanese] switches the program to the Japanese version.
 - Selecting [English] switches the program to the English version.
 - ② Select [USB connection] or [Ethernet connection] from [Interface]
 - ③ Select [Install] under [Action], and select the [Color Conversion Data] checkbox

Memo:

- You can select other checkboxes to install them simultaneously.

- Clicking [Open the Electronic Manual] opens the Electronic Manual.
- Clicking [Exit] ends the installation.

- 3 Click [Next]

- A Color Conversion Data installation screen appears.

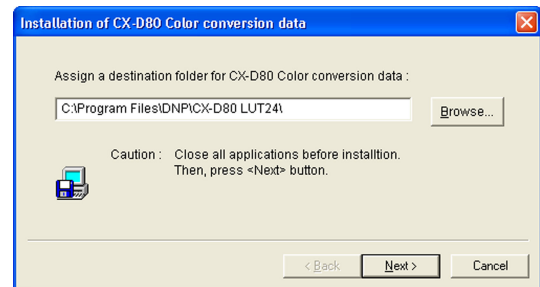

- To change the displayed installation destination, click [Browse...] and specify the destination folder.

- 4 Click [Next]

- A selection screen for registering the Color Conversion Data appears.

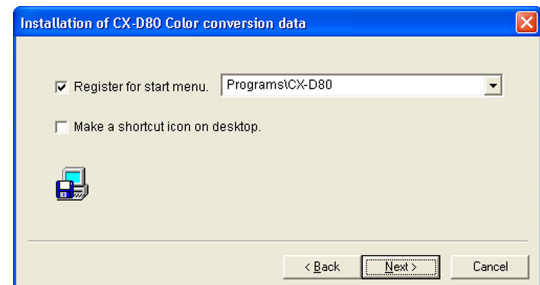

- ① Select the [Register for start menu] checkbox

- To change the registration in the displayed Start menu, make a selection from the [Register for start menu] list.

- ② Select the [Make a shortcut icon on desktop.] checkbox if necessary

- 5 Click [Next]

- Installation starts.

- After installation is complete, an installation complete screen appears.

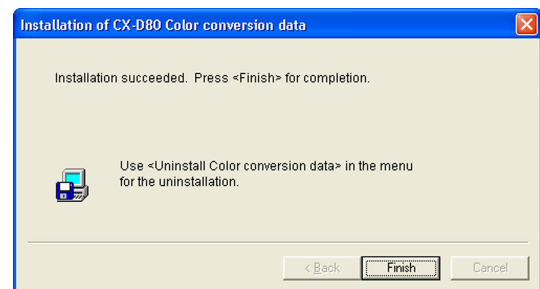

- 6 Click [Finish]

- An installation complete confirmation screen appears.

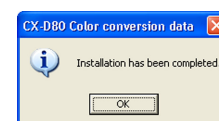

- 7 Click [OK]

- Exits the installation program.

Uninstall

Cautions:

- To uninstall the software, log into the system as an administrative user (Administrators group).
- A part of the illustrations in this Electronic Manual may not be displayed depending on the computer's environment. Skip the procedures in this case.
- "Printer Driver" (☞ page 82)
- "Status Monitor" (☞ page 85)
- "Electronic Manual" (☞ page 85)
- "Color Conversion Data" (☞ page 86)

Printer Driver

Uninstalling the Printer Driver

USB Connection

Cautions:

- Do not execute "Uninstall" if there are applications that are currently running.
- If document printing is currently in progress, wait for all the jobs to complete.

1 Start up Windows

2 Connect the computer and printer using the USB cable, and turn on the power of the printer

Cautions:

- Check to ensure that the printer connected via USB is recognized on the computer. If the USB connection is not recognized, the USB driver cannot be correctly deleted.

3 Set the supplied CD-ROM into the computer

- A card printer setup screen appears.

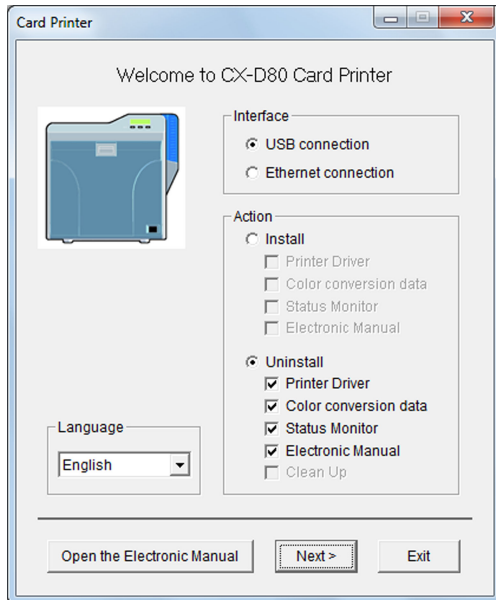

Memo:

- If the CD-ROM drive of the computer is set to run automatically, the installer will be executed automatically. If the installer is not automatically initiated, double-click "SETUP.exe" in the CD-ROM.
- If you are not using the "SETUP.exe" automatic execution program in the CD-ROM, start the uninstaller for the printer driver by double-clicking the following file in the CD-ROM: "English\USB_Soft\uninstall.exe".

Windows Vista / Windows 7 / Windows 8

- A [AutoPlay] screen appears.

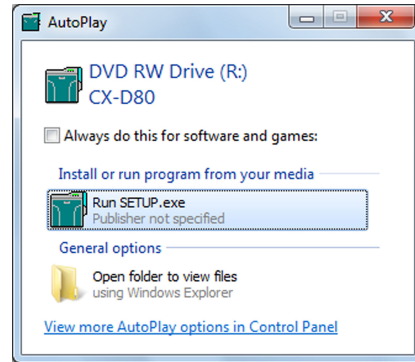

- Clicking [Run SETUP.exe] displays the [User Account Control] screen.
- Clicking [Yes] or [Allow] displays the card printer setup screen.

4 Select the [Printer Driver] checkbox on the card printer setup screen

- ① Select the language to use from the [Language] pull-down menu
 - Selecting [Japanese] switches the program to the Japanese version.
 - Selecting [English] switches the program to the English version.
- ② Select [USB connection] from [Interface]
- ③ Select [Uninstall] under [Action], and select the [Printer Driver] checkbox

Memo:

- You can select other checkboxes to uninstall them simultaneously.

5 Click [Next]

- A [Delete the CX-D80 USB printer] screen appears.

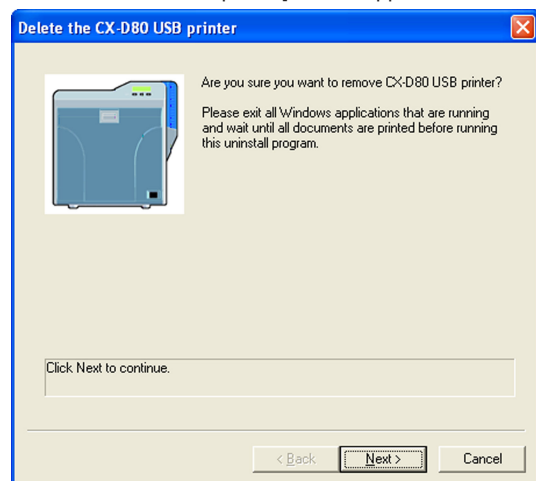

6 Check the details, followed by clicking [Next]

- A printer model selection screen appears.

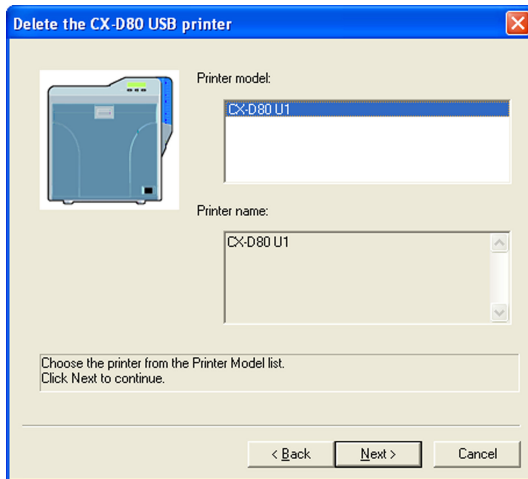

7 Select the printer to uninstall, and click [Next]

- An uninstall information confirmation screen appears.

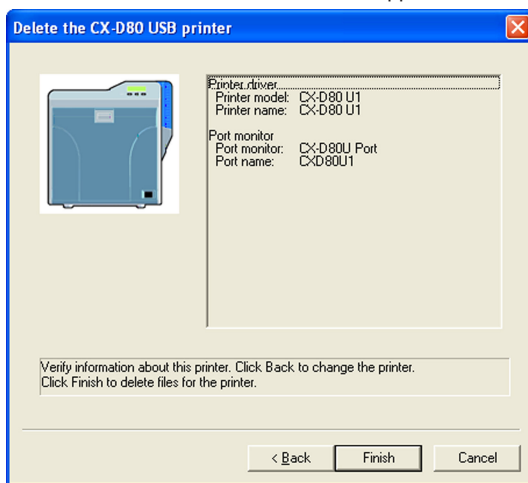

8 Check the details, followed by clicking [Finish]

- To change a printer, click [Back].

Cautions:

- Uninstall the USB printer drivers accordingly for each printer unit number.
- An uninstallation complete screen appears.

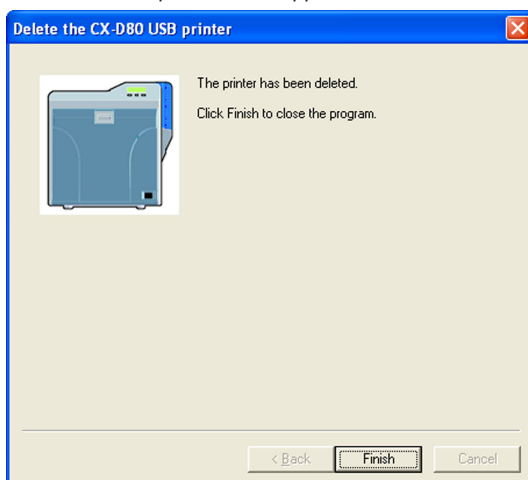

9 Click [Finish]

- Exits uninstallation.

Cautions:

- To reinstall the printer driver, perform the installation procedures after restarting Windows.

Ethernet (LAN) Connection

Cautions:

- Do not execute "Uninstall" if there are applications that are currently running.
- If document printing is currently in progress, wait for all the jobs to complete.

1 Start up Windows

- 2 Connect the computer and printer using a LAN cable, and turn on the power of the printer

Cautions:

- Do not connect a USB cable to the printer.

3 Set the supplied CD-ROM into the computer

- A card printer setup screen appears.

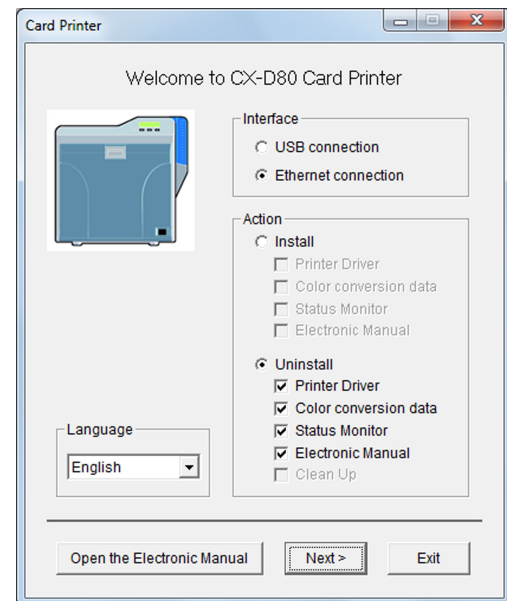

Memo:

- If the CD-ROM drive of the computer is set to run automatically, the installer will be executed automatically. If the installer is not automatically initiated, double-click "SETUP.exe" in the CD-ROM.
- If you are not using the "SETUP.exe" automatic execution program in the CD-ROM, start the uninstaller for the printer driver by double-clicking the following file in the CD-ROM: "English\LAN_Soft\uninstall.exe".

■ Windows Vista / Windows 7 / Windows 8

- A [AutoPlay] screen appears.

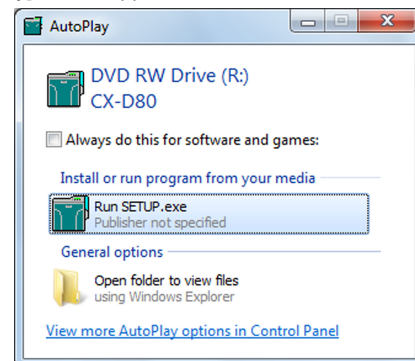

- Clicking [Run SETUP.exe] displays the [User Account Control] screen.
- Clicking [Yes] or [Allow] displays the card printer setup screen.

Setup

4 Select the [Printer Driver] checkbox on the card printer setup screen

- ① Select the language to use from the [Language] pull-down menu
 - Selecting [Japanese] switches the program to the Japanese version.
 - Selecting [English] switches the program to the English version.
- ② Select [Ethernet connection] from [Interface].
- ③ Select [Uninstall] under [Action], and select the [Printer Driver] checkbox

Memo:

- You can select other checkboxes to uninstall them simultaneously.

5 Click [Next]

- A [Delete the CX-D80 Ethernet printer] screen appears.

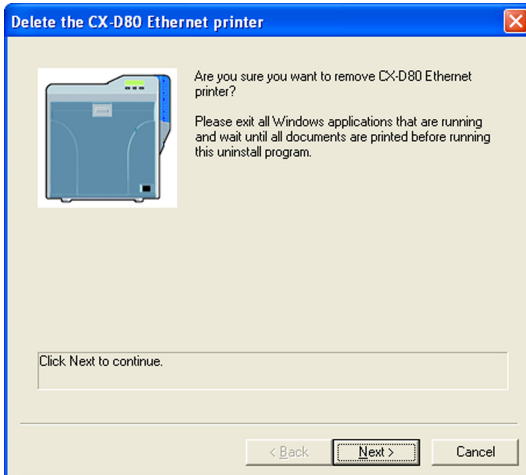

6 Check the details, followed by clicking [Next]

- A printer model selection screen appears.

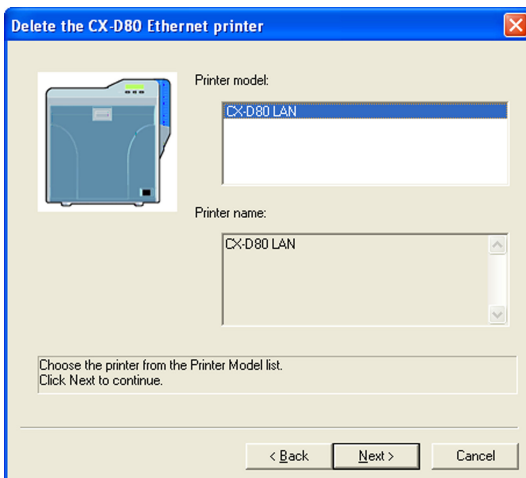

7 Select the printer to uninstall, and click [Next]

- An uninstall information confirmation screen appears.

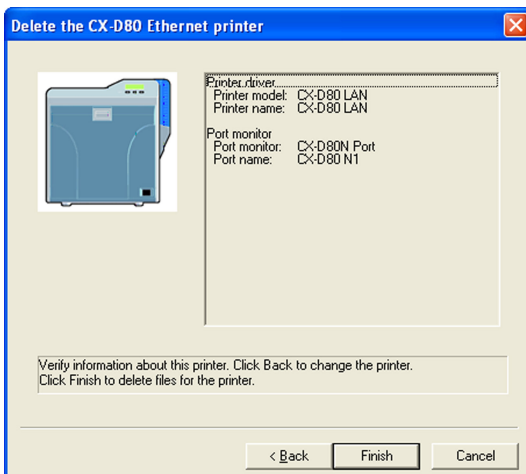

8 Check the details, followed by clicking [Finish]

- To change a printer, click [Back].

Cautions:

- In the case where multiple Ethernet (LAN) printer drivers are installed, the uninstaller deletes all of these printer drivers.
- An uninstallation complete screen appears.

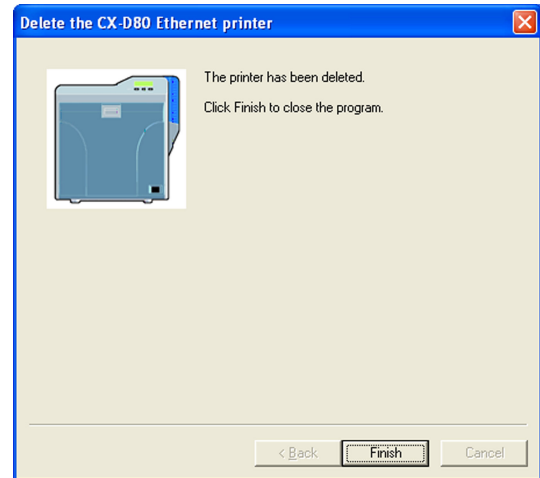

9 Click [Finish]

- Exits uninstallation.

Cautions:

- To reinstall the printer driver, perform the installation procedures after restarting Windows.

Status Monitor

Uninstalling the Status Monitor

Cautions:

- Do not execute "Uninstall" if there are applications that are currently running.
- If document printing is currently in progress, wait for all the jobs to complete.

1 Exit the status monitor

2 Select [CX-D80 Status Monitor] from [Programs and Features] or [Add or Remove Programs] in [Control Panel]

Memo:

- If the [Register for start menu] checkbox is selected during installation of the Status Monitor, delete using [Uninstall Status Monitor] from [Start menu].
- You can also perform uninstallation using the "SETUP.exe" automatic execution program.

"SETUP.exe" (☞ page 75)

- A status monitor deletion confirmation screen appears.

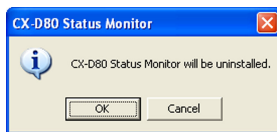

3 Click [OK]

- Uninstallation starts, and a confirmation screen for deleting the setting file appears.

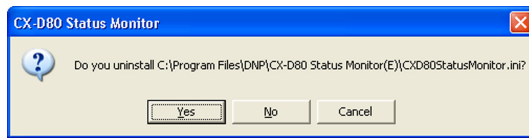

4 Click [Yes]

- Deletes the setting file for the status monitor. If you do not want to delete it, click [No].

Memo:

- If [Error] screen appears, click [OK] to proceed with the uninstallation.
- An Status Monitor deletion finish screen appears.



5 Click [Finish]

- Exits uninstallation.

Electronic Manual

Uninstalling the Electronic Manual

1 Exit the Electronic Manual

2 Select [CX-D80 Electronic Manual] from [Programs and Features] or [Add or Remove Programs] in [Control Panel]

Memo:

- If the [Register for start menu] checkbox is selected during installation of the Electronic Manual, delete using [Uninstall Electronic Manual] from [Start menu].
- You can also perform uninstallation using the "SETUP.exe" automatic execution program.

"SETUP.exe" (☞ page 80)

- An Electronic Manual deletion confirmation screen appears.

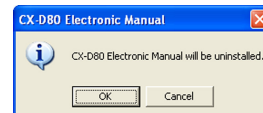

3 Click [OK]

Memo:

- If [Error] screen appears, click [OK] to proceed with the uninstallation.

- An Electronic Manual deletion finish screen appears.



4 Click [Finish]

- Exits uninstallation.

Color Conversion Data

Uninstalling the Color Conversion Data

1 If document printing is currently in progress, wait for all the jobs to complete.

2 Select [CX-D80 Color Conversion Data] from [Programs and Features] or [Add or Remove Programs] in [Control Panel]

Memo: _____

- If the [Register for start menu] checkbox is selected during installation of the Color Conversion Data, delete using [Uninstall Color Conversion Data] from [Start menu].
- You can also perform uninstallation using the "SETUP.exe" automatic execution program.

"SETUP.exe" (☞ page 81)

- A Color Conversion Data deletion confirmation screen appears.

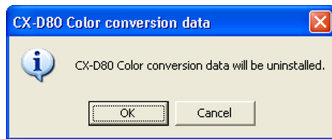

3 Click [OK]

Memo: _____

- If [Error] screen appears, click [OK] to proceed with the uninstallation.

- A Color Conversion Data deletion finish screen appears.

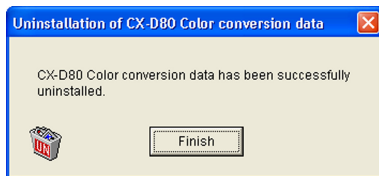

4 Click [Finish]

- Exits uninstallation.

IPSec

Setting Procedures

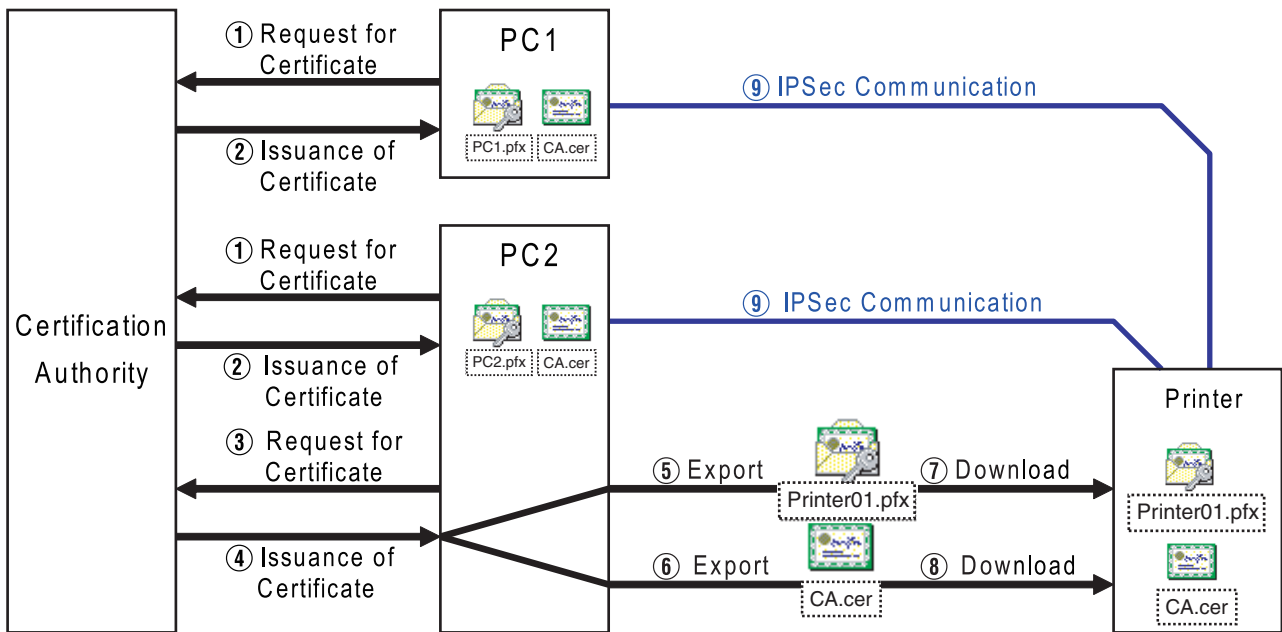

Certificate Authentication

- ① Request the "PC Certificate" from the certification authority.
- ② The "PC Certificate" and "Certification Authority Certificate" are issued by the certification authority. Install these on the PC.
- ③ Request the "Printer Certificate" from the certification authority.
- ④ The "Printer Certificate" and "Certification Authority Certificate" are issued by the certification authority. Install these on the PC.
- ⑤ Export the "Printer Certificate" and save it in a file.
- ⑥ Export the "Certification Authority Certificate" and save it in a file.
- ⑦ Connect the printer via USB, and download the "Printer Certificate" using the status monitor.
- ⑧ Connect the printer via USB, and download the "Certification Authority Certificate" using the status monitor.
- ⑨ Connect the printer via the network (Ethernet), and enable IPsec (IP Security) on the PC to start IPsec communication.

Memo:

- Consult the network administrator regarding ① to ④ above.

Preshared Key Authentication

- ① Connect the printer via USB, and download the "Preshared Key File" using the status monitor.
- ② Connect the printer via the network (Ethernet), and enable IPsec (IP Security) on the PC to start IPsec communication.

Preshared Key File

Cautions:

- Operate IPsec (IP Security) on Windows by following the instructions of the network administrator for the location where the printer is installed.
- Manage the "Preshared Key File" according to the instructions of the network administrator.

1 Start [IP Security Policy Management] under the MMC (Management Console)

2 Open the [Edit Authentication Method Properties] of the policy for which the preshared key is to be used

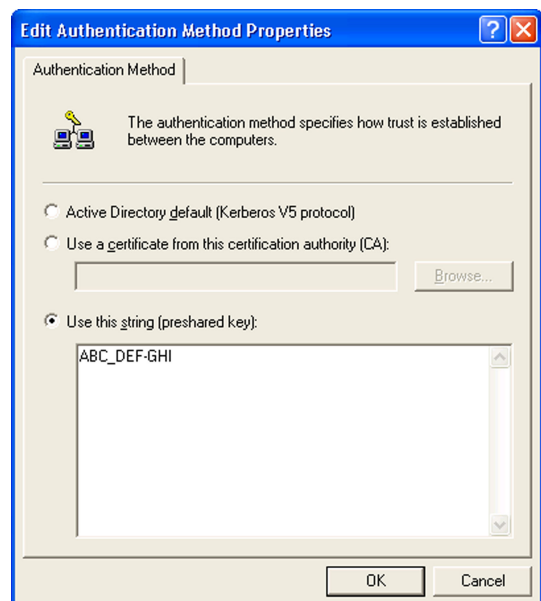

Setup

- 3 Make use of applications such as Windows Notepad to create a preshared key string, and save it as a file with the extension “.key”

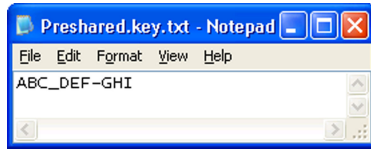

- After saving, this file will be downloaded as the “Preshared Key File” when setting “Preshared Key Authentication” using the status monitor.
- ASCII characters that can be used for the preshared key of the printer are as follows. The maximum length is 255 characters.

	2x	3x	4x	5x	6x	7x
0		0	@	P		p
1		1	A	Q	a	q
2		2	B	R	b	r
3		3	C	S	c	s
4		4	D	T	d	t
5		5	E	U	e	u
6		6	F	V	f	v
7		7	G	W	g	w
8	(8	H	X	h	x
9)	9	I	Y	i	y
A			J	Z	j	z
B			K		k	
C			L		l	
D	-		M		m	
E	.		N		n	
F			O	_	o	

Memo:

- For procedures to set “Preshared Key Authentication” on the printer, refer to the section of the Status Monitor Settings.
- “File settings required for preshared key authentication” (page 120)

Printer Certificate File

Cautions:

- Operate IPsec (IP Security) on Windows by following the instructions of the network administrator for the location where the printer is installed.
- Manage the “Printer Certificate File” according to the instructions of the network administrator.
- There is an expiration date for the “Printer Certificate”. IPsec communication may fail or may not be encrypted successfully if an expired certificate is used.

1 Obtain the printer certificate from the certification authority, and install it on the PC's [Certificates (Local Computer)]

- Obtain the printer certificate as an “exportable key”.

2 Start [Certificates (Local Computer)] under the MMC (Management Console)

3 Open the Personal Store to export the printer certificate

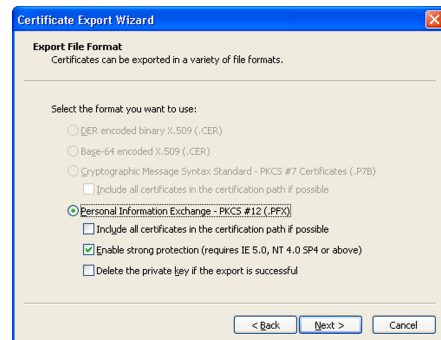

- The format is “PKCS#12”. Make sure that you specify a password. The file is saved with the extension “.pfx”.
- After saving, this file will be downloaded as the “Printer Certificate File” when setting “Certificate Authentication” using the status monitor.
- ASCII characters that can be used for the password of the printer certificate of the printer are as follows. The maximum length is 255 characters.

	2x	3x	4x	5x	6x	7x
0		0	@	P		p
1		1	A	Q	a	q
2		2	B	R	b	r
3		3	C	S	c	s
4		4	D	T	d	t
5		5	E	U	e	u
6		6	F	V	f	v
7		7	G	W	g	w
8	(8	H	X	h	x
9)	9	I	Y	i	y
A			J	Z	j	z
B			K		k	
C			L		l	
D	-		M		m	
E	.		N		n	
F			O	_	o	

Memo:

- For procedures to set "Certificate Authentication" on the printer, refer to the section of the Status Monitor Settings.

"File settings required for certificate authentication" (page 120)

Certification Authority Certificate File**Cautions:**

- Operate IPsec (IP Security) on Windows by following the instructions of the network administrator for the location where the printer is installed.
- Manage the "Certification Authority Certificate File" according to the instructions of the network administrator.
- There is an expiration date for the "Certification Authority Certificate". IPsec communication may fail or may not be encrypted successfully if an expired certificate is used.

1 Start [Certificates (Local Computer)] under the MMC (Management Console)

2 Open the Certification Authorities Store, and export the same "Certification Authority Certificate" as the printer certificate

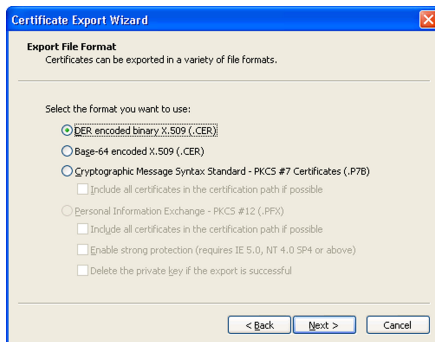

- The format is "DER encoded binary X509". The file is saved with the extension ".cer".
- After saving, this file will be downloaded as the "Certification Authority Certificate File" when setting "Certificate Authentication" using the status monitor.

Memo:

- For procedures to set "Certificate Authentication" on the printer, refer to the section of the Status Monitor Settings.

"File settings required for certificate authentication" (page 120)

Printer Driver Settings

■ "[Setup] Tab" (☞ page 90)

■ "[Print] Tab" (☞ page 90)

- "[Printing area] Dialog Box" (☞ page 92)
- "[Color] Dialog Box" (☞ page 93)
- "[Look up table] Dialog Box" (☞ page 93)
- "[Dither] Dialog Box" (☞ page 94)
- "[UV ink] Dialog Box" (☞ page 95)
- "[Printer settings] Dialog Box" (☞ page 97)

■ "[Encode] Tab" (☞ page 98)

■ "[Configuration] Tab" (☞ page 99)

■ "[Version] Tab" (☞ page 99)

Setting Example

"Example of Printer Setting" (☞ page 100)

"Example of Encode Setting" (☞ page 106)

[Setup] Tab

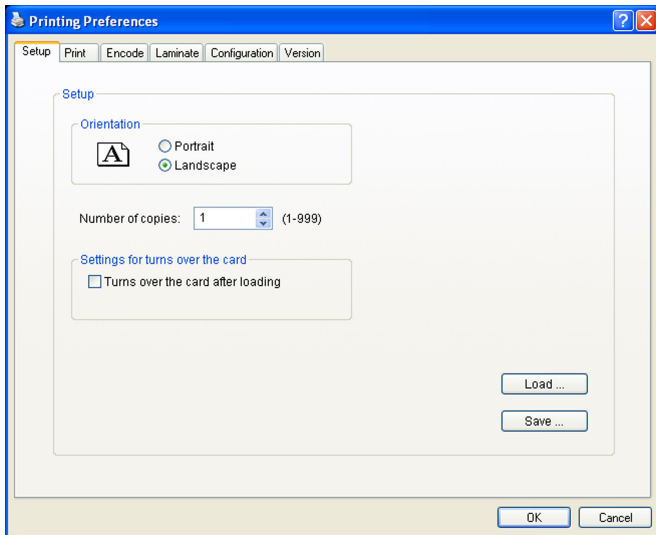

■ Orientation

Settings for printing orientation.

- Portrait
Print with the shorter edge of the card on top.
- Landscape
Print with the longer edge of the card on top.

■ Number of copies

Number of copies to print. Enter a number up to 999.

■ Settings for turns over the card

Settings for the card turn over operation.

- Turns over the card after loading
Selecting this checkbox turns over the card after it is loaded.

■ [Load...] button

Loads setting information from a specified file.

■ [Save...] button

Saves setting information to a specified file.

[Print] Tab

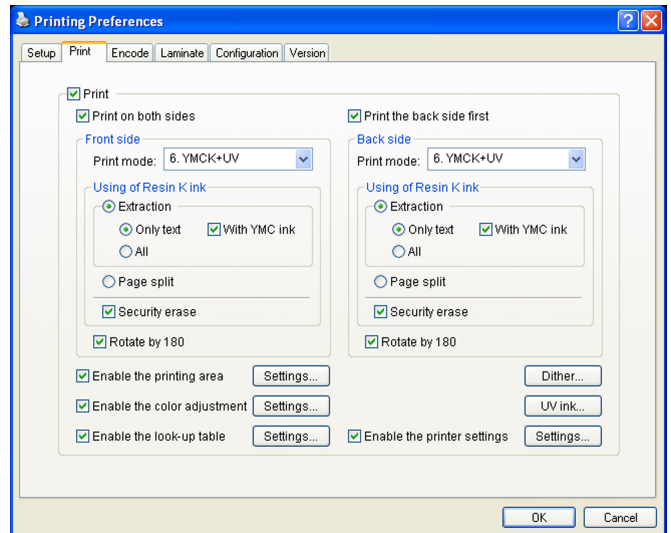

■ Print

Executes printing.

Checked : Executes printing.

Unchecked : Printing is not executed, but encoding can be performed.

■ Print on both sides

Prints both sides of the card.

Unchecked : Prints one side of the card.

Checked : Prints both sides of the card.

■ Print the back side first

Prints the image on the back side first when printing on both sides of the card.

Unchecked : Starts printing from the image on the front side.

Checked : Starts printing from the image on the back side.

Memo:

The checkbox is enabled during double-sided printing.

■ Front side/Back side

Front side : Print settings for the front side of the card.

Back side : Print settings for the back side of the card.

■ Print mode

Ink list. Specify the ink to use for printing.

- 1. YMC:
Prints using the YMC ink.
- 2. K:
Prints using the Resin K ink.
- 3. YMCK:
Prints using the YMC ink and Resin K ink.
- 4. YMC+UV:
Prints using the YMC ink. Prints data set in the [UV ink] dialog using the UV ink.
- 5. K+UV:
Prints using the Resin K ink. Prints data set in the [UV ink] dialog using the UV ink.
- 6. YMCK+UV:
Prints using the YMC ink and Resin K ink. Prints data set in the [UV ink] dialog using the UV ink.

Cautions:

- Print error occurs if an ink that is not mounted to the printer is selected.

■ Using of Resin K ink

For specifying the component to print using the Resin K ink.

- Extraction

Prints the black color component on each page using the Resin K ink.

Only text : Prints only the black color text using the Resin K ink.

All : Prints all black color components using the Resin K ink.

With YMC : Prints the background of the specified black color ink component using the YMC ink.

- Page split

Prints all components on a specific page using the Resin K ink.

- Security erase

Enables the Resin K security erase feature.

■ Rotate by 180

Prints the page upside down.

■ Enables the printing area

Enables the printing area of the peel-off ink and the area that is not printed by all (YMCKUV) inks. Set a value in the [Printing area] dialog.

Unchecked : Prints with the printing area disabled.

Checked : Prints with the preset printing area enabled.

- [Settings...] button

Opens the [Printing area] dialog.

"[Printing area] Dialog Box" (☞ page 92)

■ Enable the color adjustment

Adjusts the color. Set a value in the [Color] dialog.

Unchecked : Prints with color adjustment disabled.

Checked : Prints with the predetermined color adjustment settings enabled.

- [Settings...] button

Opens the [Color] dialog.

"[Color] Dialog Box" (☞ page 93)

■ Enable the look-up table

Uses the look-up table. Set a value in the [Look up table] dialog.

Unchecked : Prints with the look-up table disabled.

Checked : Prints with the preset look-up table enabled.

- [Settings...] button

Opens the [Look up table] dialog.

"[Look up table] Dialog Box" (☞ page 93)

■ [Dither...] button

For specifying settings related to dithering.

Set a value in the [Dither] dialog.

"[Dither] Dialog Box" (☞ page 94)

Memo:

- Selecting [2.K], [3.YMCK], [5.K+UV] or [6.YMCK+UV] in [Print mode] enables the [Dither...] button.

■ [UV ink...] button

For specifying settings related to UV ink print data.

Set a value in the [UV ink] dialog.

"[UV ink] Dialog Box" (☞ page 95)

Memo:

- Selecting [4.YMC+UV], [5.K+UV] or [6.YMCK+UV] in [Print mode] enables the [UV ink...] button.

■ Enable the printer settings

Enables the [Printer settings] dialog settings. Set the item in the [Printer settings] dialog.

Unchecked : Prints with the printer settings disabled.

Checked : Prints with the printer settings enabled.

Memo:

If the [Printer settings] checkbox in the [Configuration] tab is selected, the Enable the printer settings checkbox will also be automatically selected.

"[Configuration] Tab" (☞ page 99)

- [Settings...] button

Opens the [Printer settings] dialog.

"[Printer settings] Dialog Box" (☞ page 97)

[Printing area] Dialog Box

Settings related to the printing area using the peel-off ink or areas not to be printed using all YMCKUV inks.

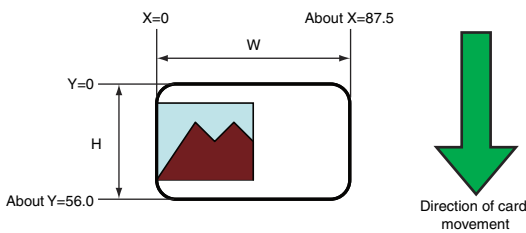
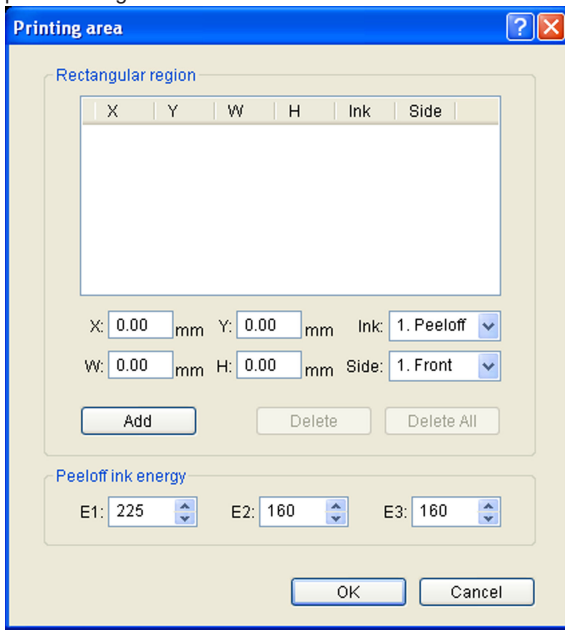

■ Rectangular region

Printing area information.

- **X**
X coordinate that indicates the start of the area. (Unit: mm).
- **Y**
Y coordinate that indicates the start of the area. (Unit: mm).
- **W**
Width of the printing area. (Unit: mm).
- **H**
Height of the printing area. (Unit: mm).
- **Ink**
Ink valid for the printing area.

- 1. Peeloff:
Area for printing using the peel-off ink.
- 2. YMCK:
Area not to be printed using all YMCKUV inks.

- **Side**
The side of the card for which the printing area is valid.

- 1. Front:
Front side
- 2. Back:
Back side

- **[Add] button**
Registers the input data. You can enter up to 8 input data.
- **[Delete] button**
Deletes the information selected in the list.
- **[Delete All] button**
Deletes all registered information.

■ **Peeloff ink energy**
Print density of the peel-off ink.
Do not alter the following values.

- E1: 225
- E2: 160
- E3: 160

■ Setting values

The following requirements must be satisfied.

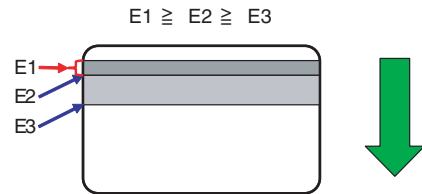

The following values are recommended when peel-off printing is performed on the ISO magnetic stripe area of the card.

X	Y	W	H	Ink	Side
0	0	87.46	17.86	1. Peeloff	1. Front
0	0	87.46	21.42	2. YMCK	1. Front

Cautions:

- The input value of the textbox may differ from the value of the "Printing area information" portion by an accidental error in calculation.

Memo:

- The printing start position displayed on the application software may not coincide with the X=0, Y=0 position above.
About 1 mm from the edge of the image is not printed on the card.
"The edge of the image is not printed" (page 128)

[Color] Dialog Box

Settings related to color adjustment.

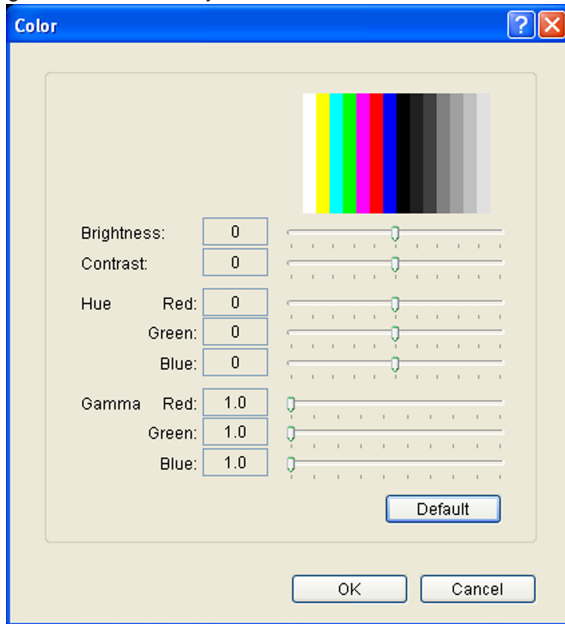
**■ Brightness**

Brightness level.

■ Contrast

Contrast level.

■ Hue

Hue level.

■ Gamma

Gamma level.

■ [Default] button

Restores the settings to the default values.

[Look up table] Dialog Box

Settings related to the look-up table.

- Select YMCK conversion table or full color conversion.
- By selecting the checkbox at the beginning of a line in the list, the look-up table of that line is enabled.

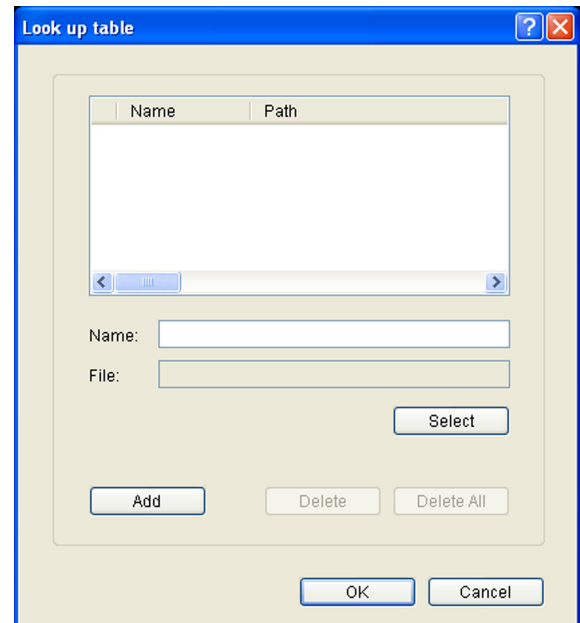
**■ Name**

Registered name of the look-up table file. You can enter a name up to 30 characters.

■ File

Look-up table file. Click the [Select] button to select a file.

Memo:

- For YMCK conversion table, select the look-up table file (*.CSV) in CSV format.
- For full color conversion, select the look-up table file (*.LUT) of the Color Conversion Data.

■ [Add] button

Registers the input data. You can enter up to 16 input data.

■ [Delete]

Deletes the information selected in the list.

■ [Delete All]

Deletes all registered information.

■ Registering the look-up table file

- ① Click [Select]
- An [Open] screen appears.

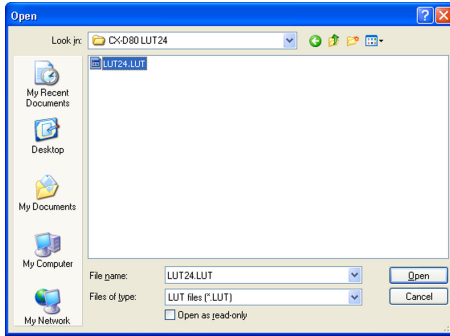

- ② Select from [Look in] the folder where the look-up table file is saved
- ③ Select the file format at [Files of type]
 - If [CSV files (*.CSV)] is selected, the look-up table file in CSV format is displayed.
 - If [LUT files (*.LUT)] is selected, the look-up table file of the Color Conversion Data is displayed.
- ④ Select the file
- ⑤ Click [Open]
 - The [Open] screen closes.
 - The file selected in [File] is displayed.
- ⑥ Enter the registered name in [Name]
- ⑦ Click [Add]
 - The registered name is displayed in the list.

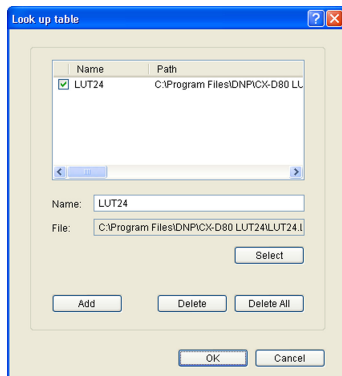

- ⑧ Select the checkbox at the beginning of the line in the list
- ⑨ Click [OK]

■ File for YMCK conversion table

- Data format of the file is CSV (Comma Separated Values).
- Delimiter character is comma (ASCII character code: 0x2c) or LF (Line Feed = ASCII character code: 0x0A).
- There is a total of 1024 fields. This is comprised of four planes, each containing 256 fields.
- The planes are arranged in the order of yellow, magenta, cyan, and black colors.
- The value of each field ranges between 0 and 255.

■ Full color conversion data

- The full color conversion data file is saved in the folder specified at "Installing the Color Conversion Data".
- It may take longer time to print if full color conversion is used.

Cautions:

- If the look-up table file is incorrect, error will be displayed during printing and the printing will stop.

[Dither] Dialog Box

Settings related to dithering.

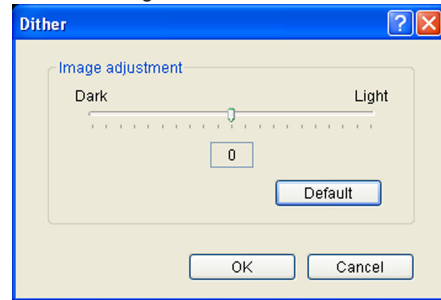

Cautions:

- This setting is enabled only when the [Print mode] item inside the [Print] tab is specified as [2.K] or [5.K+UV], and when the [Page split] is selected for [Using of Resin K ink].

■ Image adjustment

Image adjustment value.

- Dark: Darkens the printed image after dithering.
- 0: Default value.
- Light: Brightens the printed image after dithering.

■ [Default] button

Restores the settings to the default values.

[UV ink] Dialog Box

Settings related to the data to be printed using the UV ink. Settings for the [MAC address position] and [Number of panels using the retransfer film] can be specified in this section.

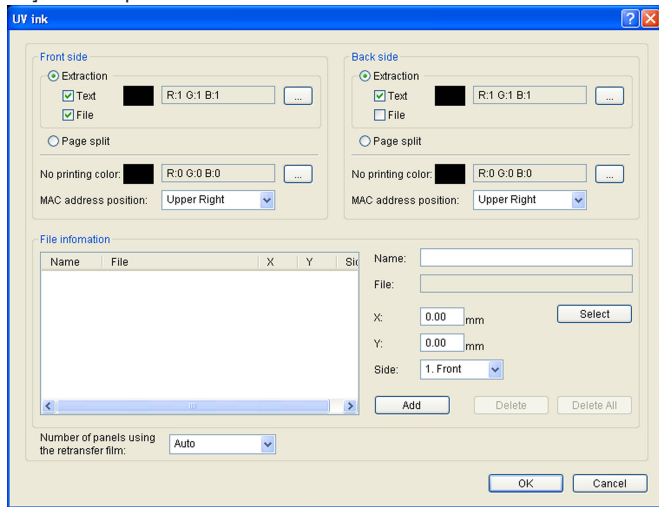

Cautions:

- This setting is enabled only when the [Print mode] item of the [Print] tab is specified as [4.YMC+UV], [5.K+UV] or [6.YMCK+UV].

■ Front side/Back side

Front side: Settings for the front side of the card.

Back side: Settings for the back side of the card.

■ Extraction

Prints the following color component on each page using the UV ink. "Priority of printing data" (☞ page 95)

- Text**
Prints the text of a specified color using the UV ink with maximum density. White and black colors cannot be selected.
- File**
Prints the image files registered in the [File information] list using the UV ink.

■ Page split

Prints all components on a specific page using the UV ink with 256 gradation. Page split is divided in the order of YMC ink, Resin K ink and UV ink.

"Page number for the printed document and page split settings" (☞ page 96)

■ No printing color

Selected color is not printed using the UV ink.

Memo:

- The background of the UV ink image is specified here. Paint the background of the image with a specific color such as by using a graphic software. Select the background color carefully, as any color in the image that is the same as the background color will not be printed.
- The color selected here does not influence the colors specified in [Extraction]-[Text]. Even when the same color is selected, the text in that color will be printed.

■ MAC address position

The network (Ethernet) MAC address of the printer is printed at the following specified position using the UV ink.

- Upper Right:
Upper right position
- Lower Left:
Lower left position

"MAC Address Position" (☞ page 96)

■ File information

Settings related to the image file to be printed using the UV ink.

Memo:

- This setting is enabled when [Extraction]-[File] for the front side or back side is specified.

■ Name

Registered name of the image file. You can enter a name up to 30 characters.

■ File

Image file. Click the [Select] button to select a file.

"Windows Bitmap File Format" (☞ page 96)

■ X

X coordinate where printing of the image file starts. (Unit: mm).

When [Orientation] inside the [Setup] tab is set to [Landscape], the value is 0.00 to 87.4. When [Portrait] is set, the value is 0.00 to 55.9. Data outside the printing area is not printed.

■ Y

Y coordinate where printing of the image file starts. (Unit: mm).

When [Orientation] inside the [Setup] tab is set to [Landscape], the value is 0.00 to 55.9. When [Portrait] is set, the value is 0.00 to 87.4. Data outside the printing area is not printed.

■ Side

The side of the card for which the printing area is valid.

- 1. Front:
Front side
- 2. Back:
Back side

■ [Add] button

Registers the input data. You can enter up to 8 input data.

■ [Delete] button

Deletes the information selected in the list.

■ [Delete All] button

Deletes all registered information.

■ Number of panels using the retransfer film

Number of retransfer film panels to be used.

- Auto:
Automatically prints one panel of the retransfer film when the data of other ink types does not overlap with the UV ink printing position.
- 1 panel:
Always prints one panel of the retransfer film. When the data of other ink types overlaps with the UV ink printing position, the data of the ink types will be adjusted.
- 2 panels:
Always prints two panels of the retransfer film.

"Number of retransfer film panels during printing" (☞ page 97)

Priority of printing data

- An extracted text has a higher priority than an image file, and is always printed on the top.
- The image files are processed in the order of registration. When there is overlap in the printing areas, the older data will be overwritten by the data of the image file that is registered later.

Page Number for the Printed Document and Page Split Settings

setup of [Page split]				The page number of the printing document					
Resin K ink		UV ink							
Front	Back	Front	Back	1	2	3	4	5	6
—	—	—	—	YMCK	YMCK				
set	—	—	—	YMC	K	YMCK			
—	—	set	—	YMCK	UV	YMCK			
set	—	set	—	YMC	K	UV	YMCK		
—	set	—	set	YMCK	YMC	K	UV		
set	set	—	—	YMC	K	YMC	K		
—	—	set	set	YMCK	UV	YMCK	UV		
set	set	set	—	YMC	K	UV	YMC	K	
set	set	set	set	YMC	K	UV	YMC	K	UV

ink This ink is printed on the front side. ink This ink is printed on the back side.

- When [Page split] is not set, UV ink data is extracted from the YMC ink data, or the UV ink image file is used.

MAC Address Position

- In the case of UV ink printing, the printer always prints the MAC address.
- The printing position of the MAC address can be set separately for the front and back sides using the printer driver. The two positions below can be selected.

■ [Landscape] Orientation

① MAC address printing position when [Upper Right] is selected
 ② MAC address printing position when [Lower Left] is selected
 ③ (X=0, Y=0)
 ④ (X = approx. 87.5 mm, Y = approx. 56.0 mm), (X = 1035 pixel, Y = 663 pixel)

MAC Address Printing Position	Starting X	Starting Y	Width	Height
①Upper Right	64.69 mm	1.52 mm	19.47 mm	2.88 mm
	764 pixel	18 pixel	230 pixel	34 pixel
②Lower Left	3.56 mm	51.73 mm	19.47 mm	2.88 mm
	42 pixel	611 pixel	230 pixel	34 pixel

■ [Portrait] Orientation

① MAC address printing position when [Upper Right] is selected
 ② MAC address printing position when [Lower Left] is selected
 ③ (X=0, Y=0)

MAC Address Printing Position	Starting X	Starting Y	Width	Height
①Upper Right	51.82 mm	64.69 mm	2.88 mm	19.47 mm
	612 pixel	764 pixel	34 pixel	230 pixel
②Lower Left	1.61 mm	3.56 mm	2.88 mm	19.47 mm
	19 pixel	42 pixel	34 pixel	230 pixel

- The above printing position setting for the MAC address is always effective regardless of the printer unit settings. The above measurements show the relative position from the starting point of the image. As such, the actual printing position on the card may be slightly different from the abovementioned measurements.

Memo: _____
 • The printing start position displayed on the application software may not coincide with the X=0, Y=0 position above. About 1 mm from the edge of the image is not printed on the card. "The edge of the image is not printed" (see page 128)

Windows Bitmap File Format

The following Windows bitmap file formats (*.BMP) are supported.

■ Monochrome/Black & white

- Bit(s): 1
 Normally, white color is printed using the UV ink with maximum density. When white color is selected in [No printing color], black color is printed using the UV ink with maximum density.

■ 2 colors

- Bit(s): 1
 Prints using the UV ink with 256 gradation in accordance with the color palette. If any of the colors in the color palette is specified in [No printing color], other colors that are not specified are printed using the UV ink with maximum density.

■ 16 colors

- Bit(s): 4
 Prints using the UV ink with 256 gradation in accordance with the color palette.

■ **256 colors**
 ● Bit(s): 8
 Prints using the UV ink with 256 gradation in accordance with the color palette.

■ **32768 colors**
 ● Bit(s): 15
 Prints using the UV ink with 256 gradation. Only the "(MSB) GGGBBBBB-XRRRRRGG(LSB)" format is supported.

■ **24 bits**
 ● Bit(s): 24
 Prints using the UV ink with 256 gradation.

■ **32 bits**
 ● Bit(s): 32
 Prints using the UV ink with 256 gradation.

Number of retransfer film panels during printing

	Printing Data	[Number of panels using the retransfer film] Setting		
		1 Panel	Auto	2 Panels
Printing data that overlaps with the UV ink data outside the MAC address printing area	None	Print in 1 panels		Print in 2 panels
	YMC Ink	Print in 1 panels * The YMC ink is not printed at areas where it overlaps with the UV ink.	Print in 2 panels	
	K Ink	Print in 1 panels * The UV ink is not printed at areas where it overlaps with the K ink.	Print in 2 panels	
Printing data inside the MAC address area	None	Print in 1 panels		Print in 2 panels
	YMC Ink	Print in 1 panels * Does not print using the YMCK ink.	Print in 2 panels	
	K Ink	Print in 2 panels		
	UV Ink	Prints the MAC address only		

The target printing data is compared in units of pixels to determine whether there is any overlap. Priority is given to the "Print in 2 panels" setting.

[Printer settings] Dialog Box

Settings related to the printer. Select the checkbox for the setting item to enable, followed by specifying a value. Doing so prints the data using the set values. When the setting is not enabled, data is printed using the preset values of the printer unit.

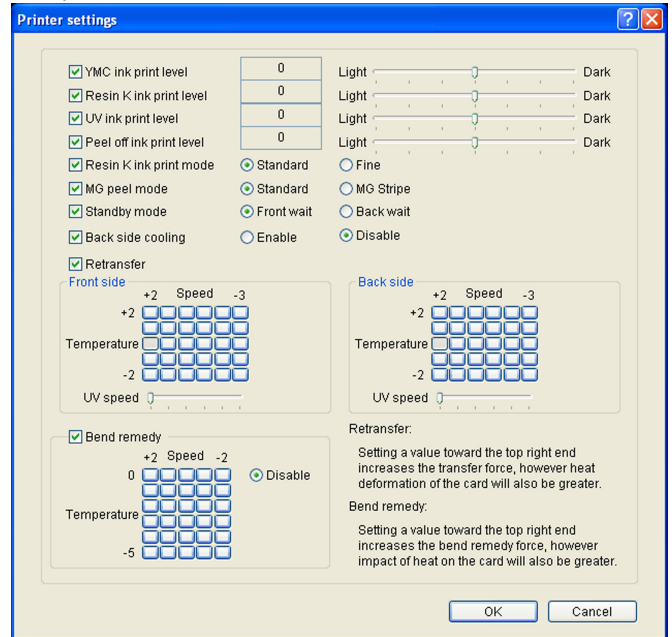

■ **YMC ink print level**

Print density of the YMC ink. Use the [+] values to increase, and [-] values to decrease the density.

■ **Resin K ink print level**

Print density of the Resin K ink. Use the [+] values to increase, and [-] values to decrease the density.

■ **UV ink print level**

Print density of the UV ink. Use the [+] values to increase, and [-] values to decrease the density.

■ **Peel off ink print level**

Print density of the peel-off ink. Use the [+] values to increase, and [-] values to decrease the density.

■ **Resin K ink print mode**

Print quality of the Resin K ink. Selecting [Fine] enhances the printing quality, but slows down the printing speed.

■ **MG peel mode**

When a magnetic encoder unit is installed, selecting [MG Stripe] optimizes the peeling operation of retransfer films for magnetic stripe cards.

■ **Standby mode**

Specify a position when a laminator is connected. This is used for setting the standby position of the card during double-sided printing until the laminator is ready. [Front wait] is selected by default.

■ **Back side cooling**

This setting is only valid during double-sided printing. Setting this item may help to reduce card bend during double-sided printing. However, the printing time may also be affected.

Retransfer

Settings related to retransfer. Click on the corresponding square to change the value.
Setting a value toward the top right end increases the transfer force. However, the stronger heat also increases the deformation of the card.

- Temperature
Temperature of the retransfer heating roller.
- Speed
Retransfer speed.
- UV speed
Setting for printing the retransfer film in two panels when UV ink is used.
It is used to set the speed of the retransfer heating roller during retransfer of the UV ink.
This setting helps to increase the retransfer speed without affecting the quality of the UV print.

Bend remedy

Settings related to bend remedy.
Click on the corresponding square to change the value.
Setting a value toward the top right end increases the bend remedy force. However, the stronger heat may have a greater impact on the card.
To disable bend remedy, select the [Disable] button.

- Temperature
Temperature of the bend remedy heating roller.
- Speed
Bend remedy speed.

Cautions:

- The optimal retransfer and bend remedy settings vary according to the card type as well as environment in which the printer is used. Adjust the setting according to the actual environment.
- If the retransfer or bend remedy settings are different from the preset temperature of the printer, it may take a while before printing starts.
- There is only one standard retransfer temperature. Altering the retransfer temperature on one side changes the temperature on the other side.
- Bend remedy is effective when printing on only one side. Setting bend remedy to a high temperature during double-sided printing may cause the card to deform significantly.
As such, select the [Disable] button during double-sided printing.
- When bend remedy is disabled using the [Disable] button, the speed is automatically set to the maximum value of [+2].
- The stronger the bend remedy force, the less glossy the surface of the remedy side will be.

[Encode] Tab

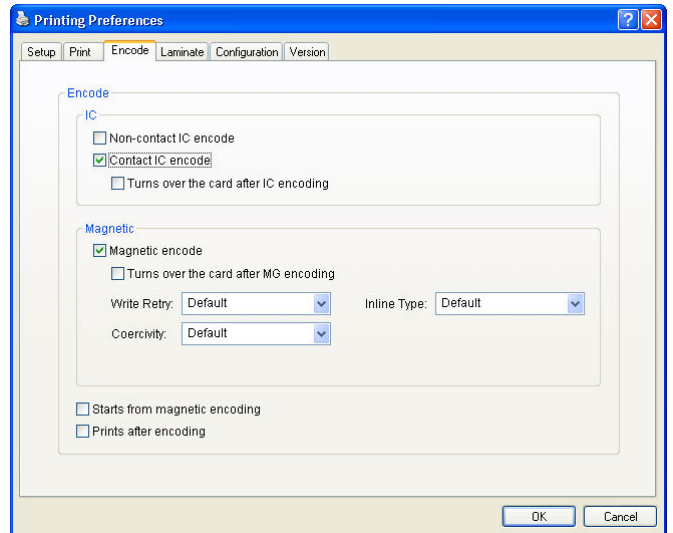

IC

Non-contact IC encode

Allows writing of data to a non-contact IC.

Contact IC encode

Allows writing of data to a contact IC.

Turns over the card after IC encoding

Turns over the card after writing data to the non-contact/contact IC.

Magnetic

Magnetic encode

Allows writing of data to the magnetic stripe.

Turns over the card after MG encoding

Turns over the card after writing data to the magnetic stripe.

Write Retry

For setting the maximum number of retries when writing to or reading of the magnetic stripe fails.
When the [Default] is selected, the retry counter uses the preset value of the printer.

Coercivity

Coercivity of the magnetic stripe card.
When the [Default] is selected, the coercivity uses the preset value of the printer.

Inline type

Select the methods of inline encoding. This method functions when the [ISO Magnetic encoder] in the [Configuration] tab is effective.

"Inline Encoding" (page 123)

- Default :
This method is the current default encoding.
- Type B :
The method of Type B encoding.
- Type C :
The method of Type C encoding.
- None :
ISO Magnetic encoding data does not use the inline encoding.

Starts from magnetic encoding

Unchecked : Encodes in the IC→Magnetic sequence.

Checked : Encodes in the Magnetic→IC sequence.

Prints after encoding

Unchecked : Starts printing while encoding is in progress.

Checked : Starts printing after encoding is complete.

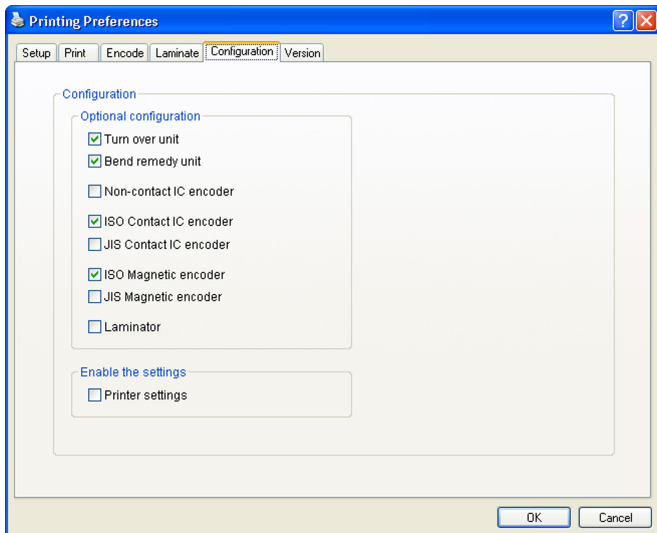
[Configuration] Tab**■ Optional configuration**

For specifying whether the options are installed.

- Turn over unit
- Bend remedy unit
- Non-contact IC encoder
- ISO Contact IC encoder
- JIS Contact IC encoder
- ISO Magnetic encoder
- JIS Magnetic encoder
- Laminator

■ Enable the settings

Permits or forbids the [Enable the printer settings] functions in the [Print] tab.

■ Printer settings

Unchecked : Forbids the [Enable the printer settings] functions in the [Print] tab.

Checked : Permits the [Enable the printer settings] functions in the [Print] tab.

"Enable the printer settings" (☞ page 91)

Cautions:

- When a user logs in with administrator authority (Administrators group), the [Configuration] settings can be specified. If a user logs in without administrator authority, the [Configuration] settings appear in the read-only mode, and they cannot be specified.

[Version] Tab

Displays the version and copyright information.

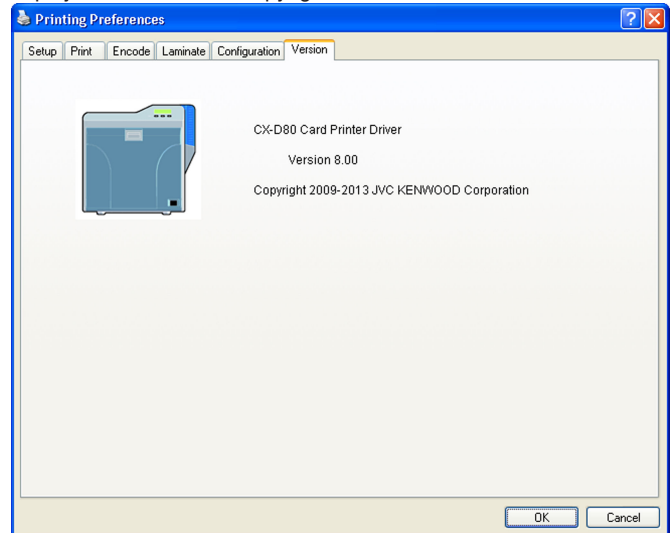

Example of Printer Setting

Single-sided Printing (Landscape)

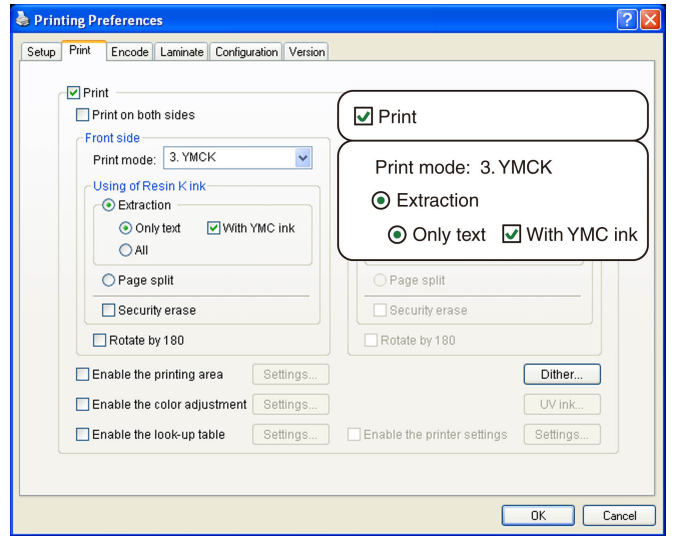
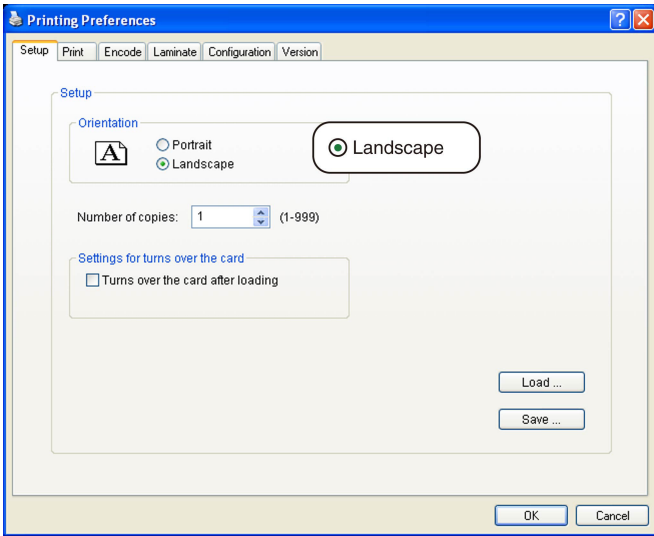

■ Application software

- Graphic: colored
- Text: black

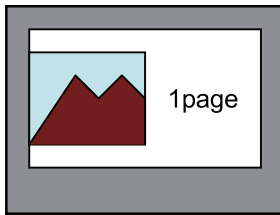

■ Printer

- Graphic: YMC ink
- Text: YMC ink + Resin K ink

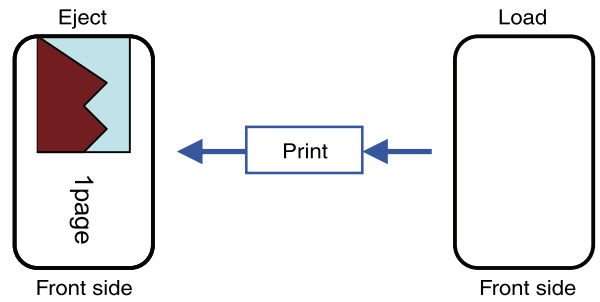

Single-sided Printing (Portrait)

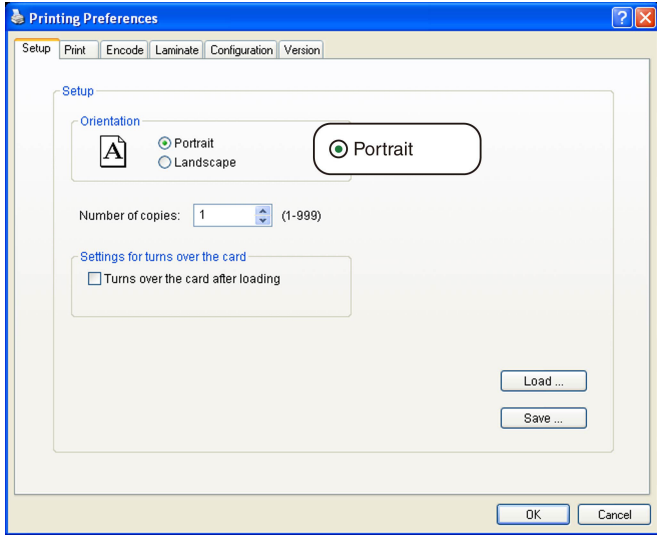

■ Application software

- Graphic: colored
- Text: black

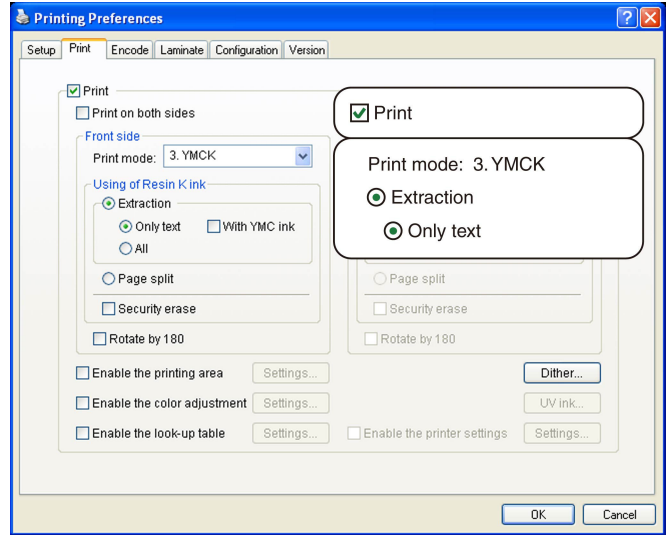
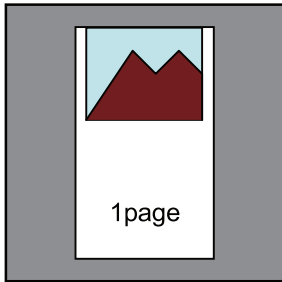

■ Printer

- Graphic: YMC ink
- Text: Resin K ink

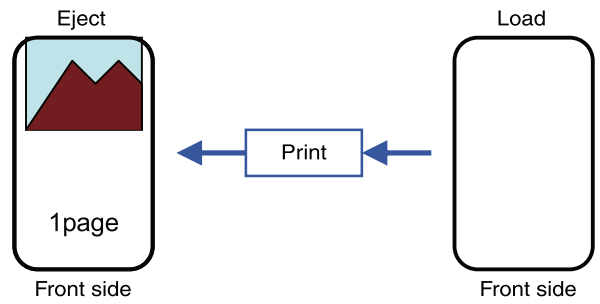

Double-sided Printing (Default)

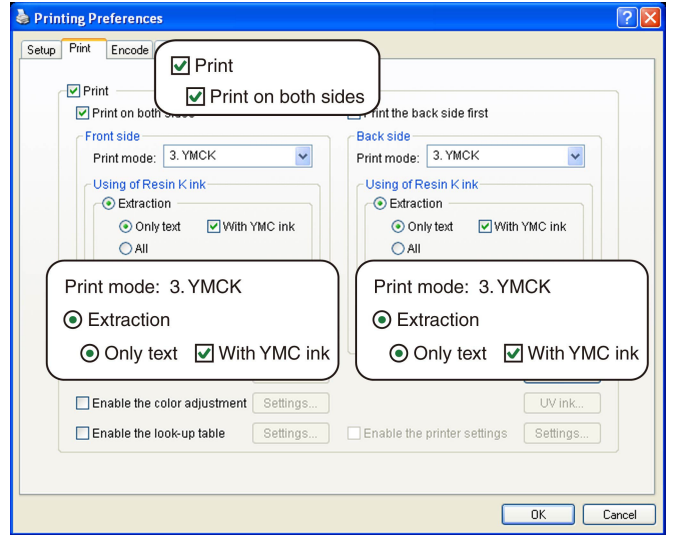
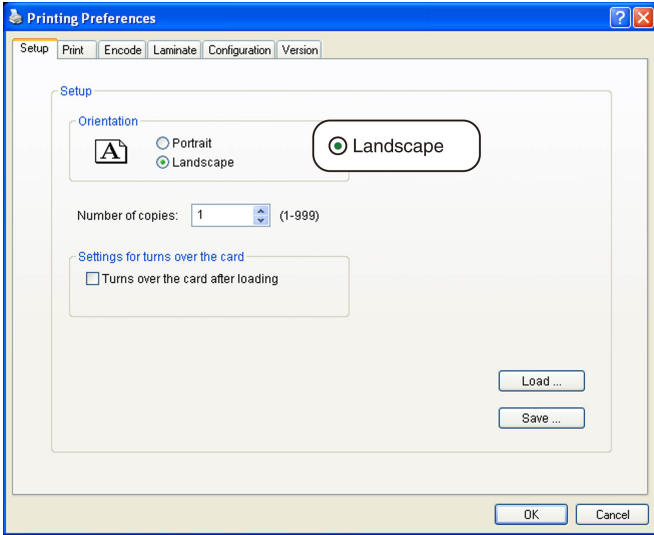

■ Application software

- Graphic: colored
- Text: black

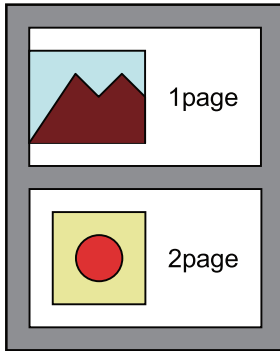

■ Printer

- Graphic: YMC ink
- Text: YMC ink + Resin K ink

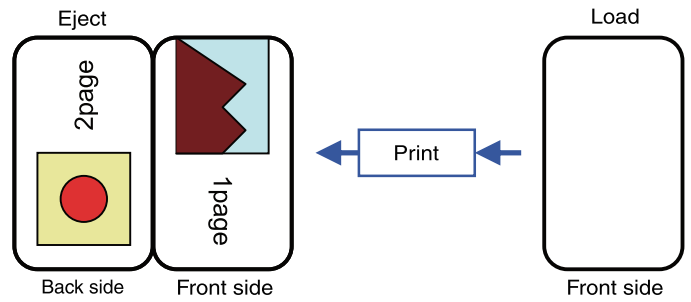

Double-sided Printing (Single-side Lamination)

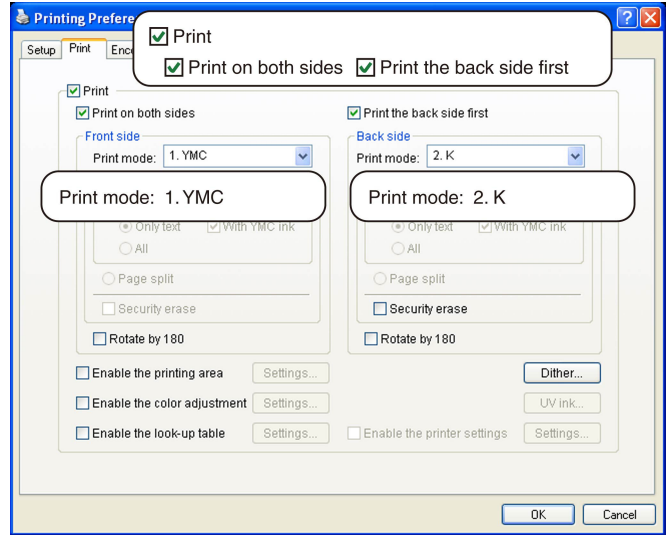
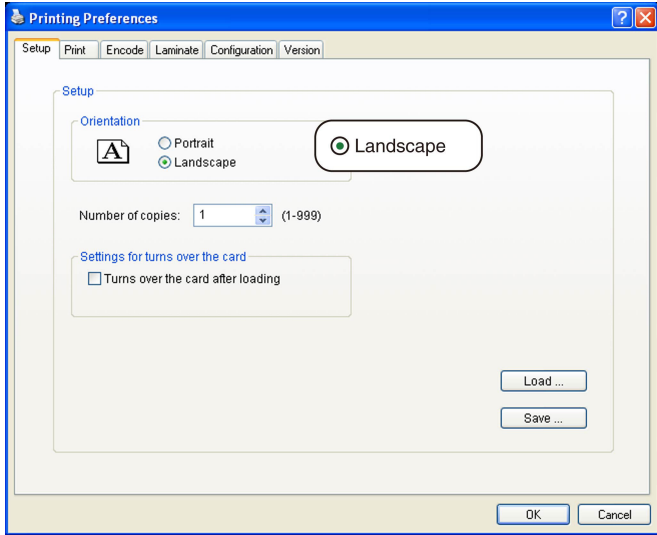

Application software

Page 1

- Graphic: colored
- Text: colored

Page 2

- Graphic: black
- Text: black

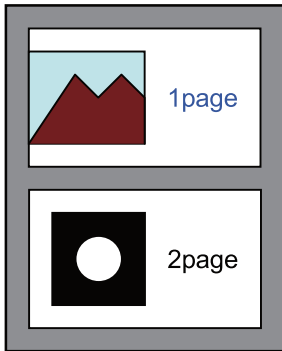

Printer

Front side

- Graphic: YMC ink
- Text: YMC ink

Back side

- Graphic: Resin K ink
- Text: Resin K ink

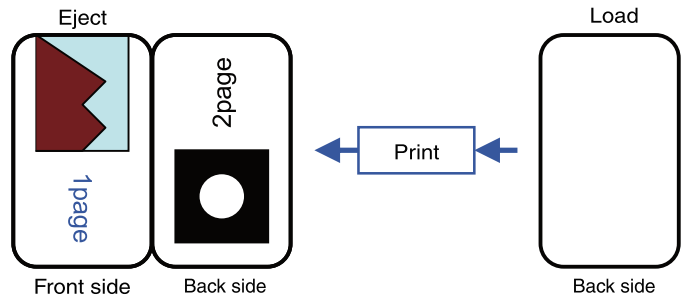

Memo:

- If page 2 is set as colored, printing is performed using the Resin K ink after dithering is complete.

"[Dither] Dialog Box" (page 94)

Single-sided UV Printing

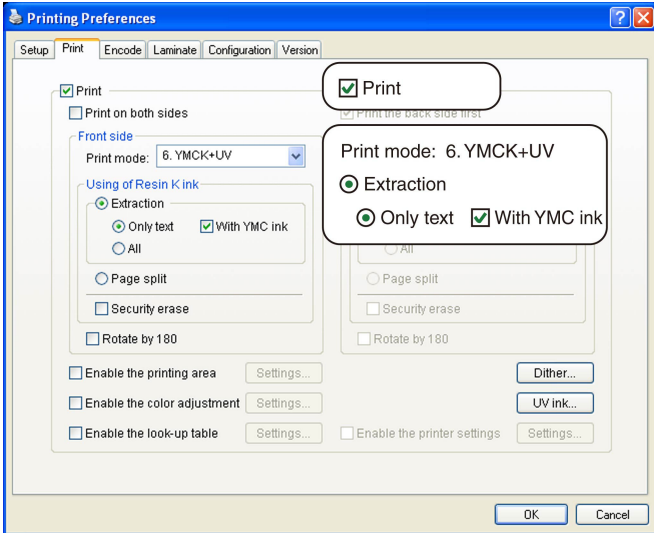

Clicking [UV ink...] opens the [UV ink] dialog box.

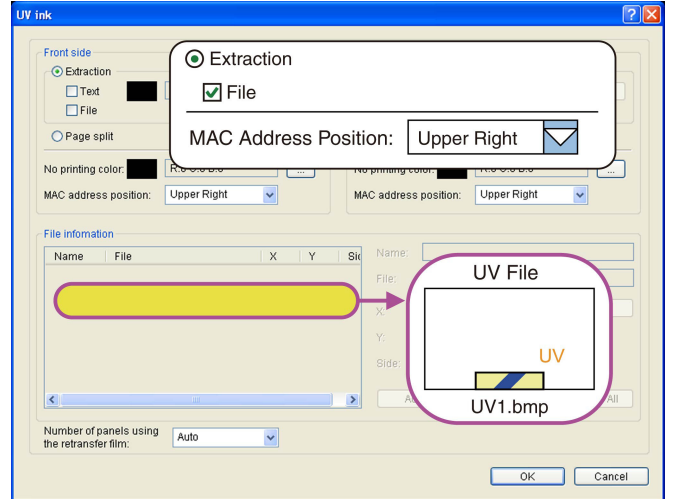

■ Application software

- Graphic: colored
- Text: black

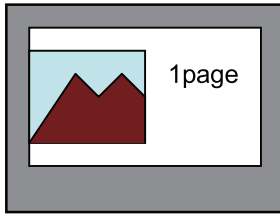

■ Printer

- Graphic: YMC ink
- Text: YMC ink + Resin K ink
- UV1.bmp: UV ink
- MAC address: UV ink

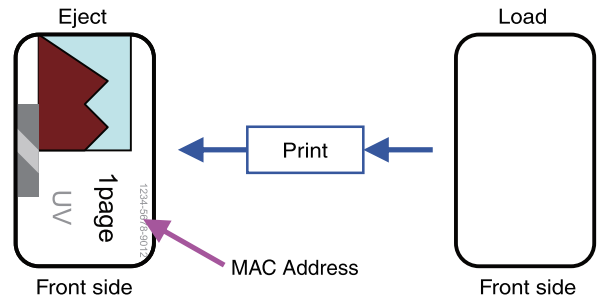

Page Split

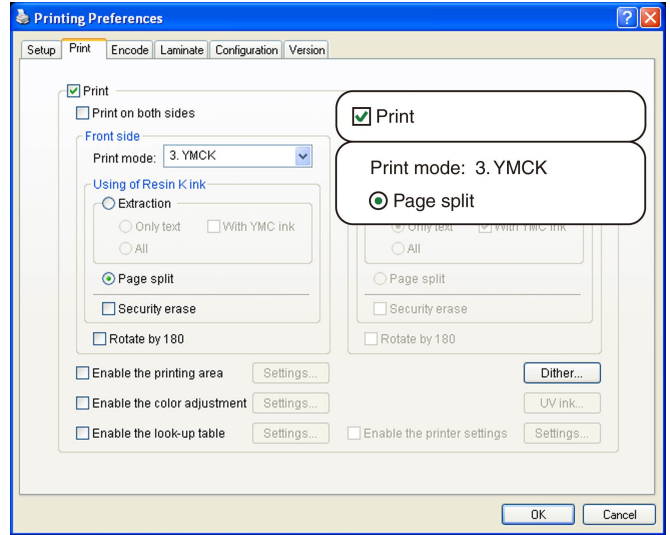
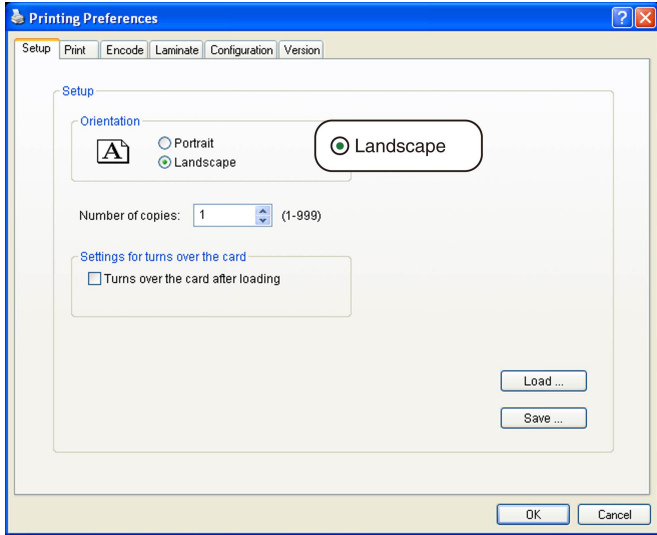

■ Application software

Page 1

- Graphic: colored
- Text: colored

Page 2

- Graphic: black
- Text: black

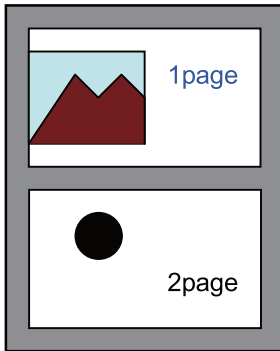

■ Printer

- Graphic: YMC ink + Resin K ink
- Text: YMC ink + Resin K ink

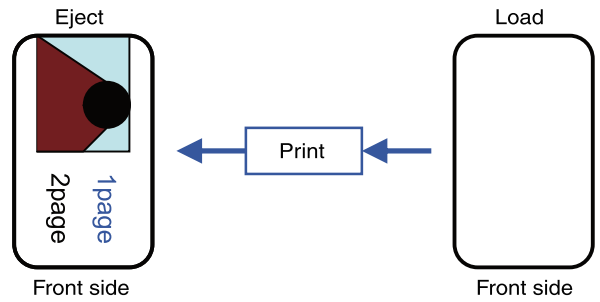

Example of Encode Setting

Encoding Only (ISO Card)

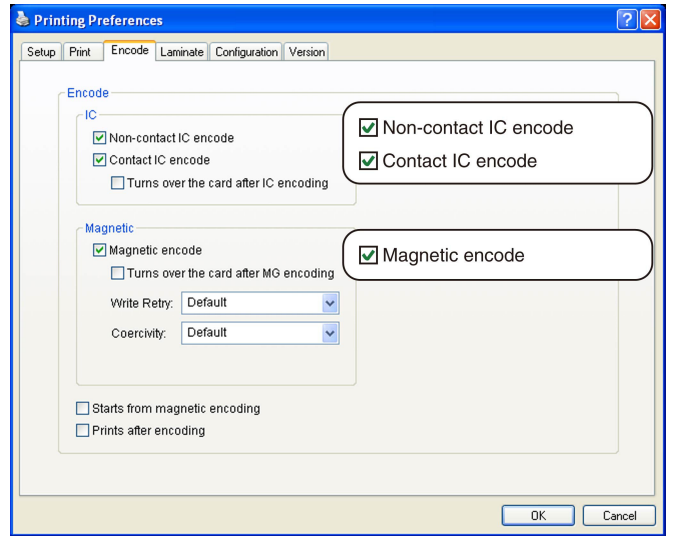
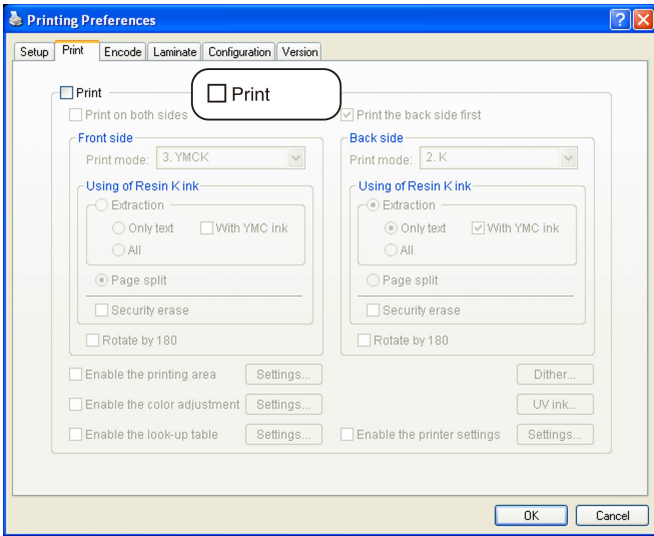

Application software

- Graphic: colored
- Text: black

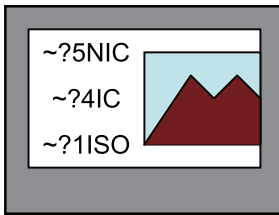

Printer

- Graphic: none
- Text: none

Inline Encoding

- Non-contact IC encode data: NIC
- Contact IC encode data: IC
- ISO track 1 magnetic encode data: ISO

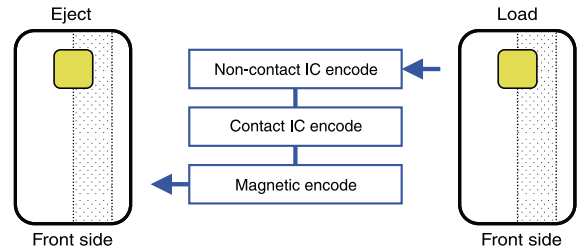

Encoding and Printing (ISO Card)

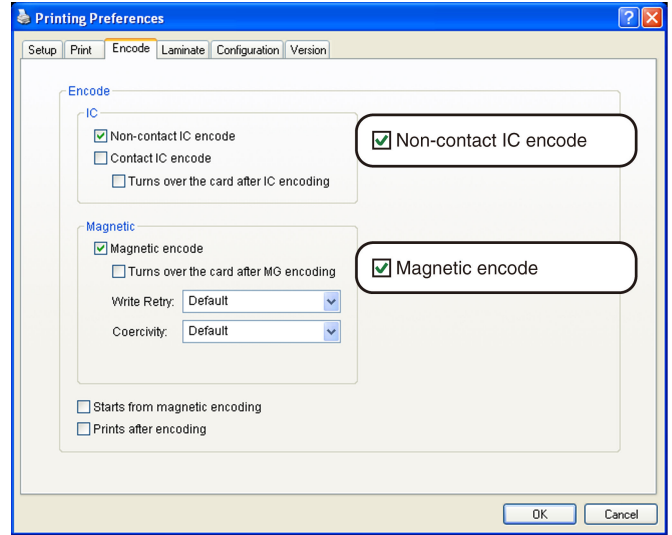
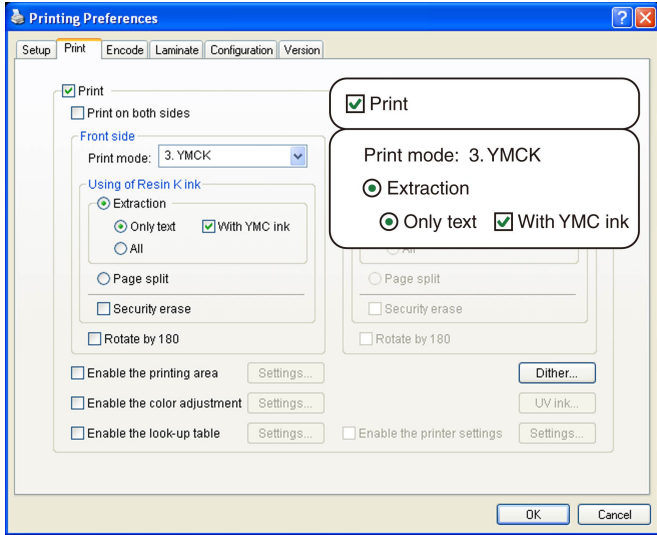

■ Application software

- Graphic: colored
- Text: black

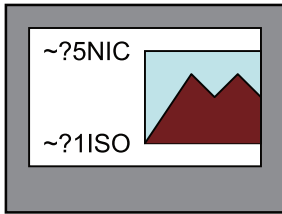

■ Printer

- Graphic: YMC ink
- Text: YMC ink + Resin K ink

■ Inline Encoding

- Non-contact IC encode data: NIC
- ISO track 1 magnetic encode data: ISO

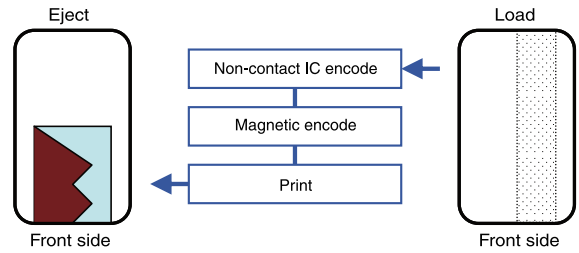

Encoding and Printing (JIS Card)

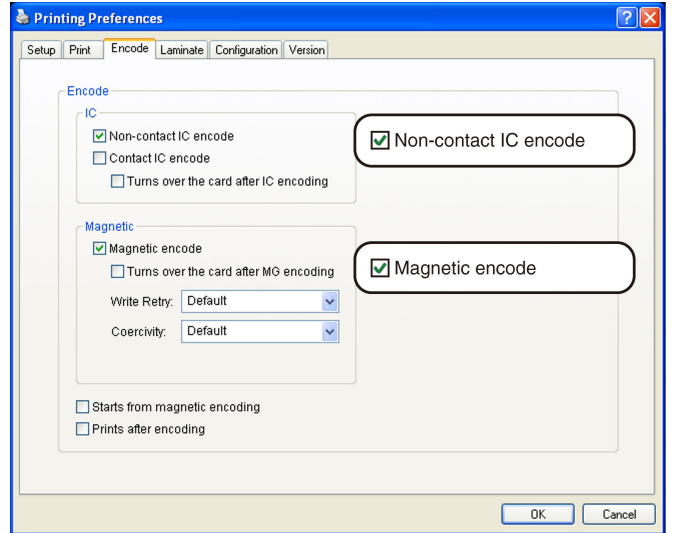
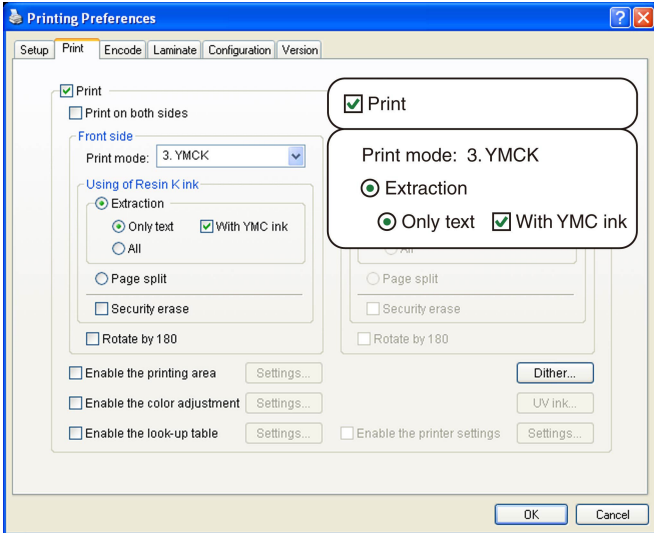

■ Application software

- Graphic: colored
- Text: black

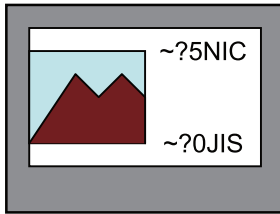

■ Printer

- Graphic: YMC ink
- Text: YMC ink + Resin K ink

■ Inline Encoding

- Non-contact IC encode data: NIC
- JIS2 magnetic encode data: JIS

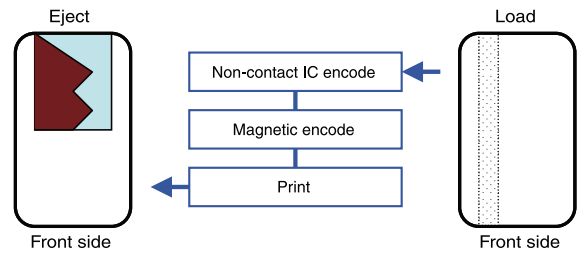

Card Turn Over Illustration

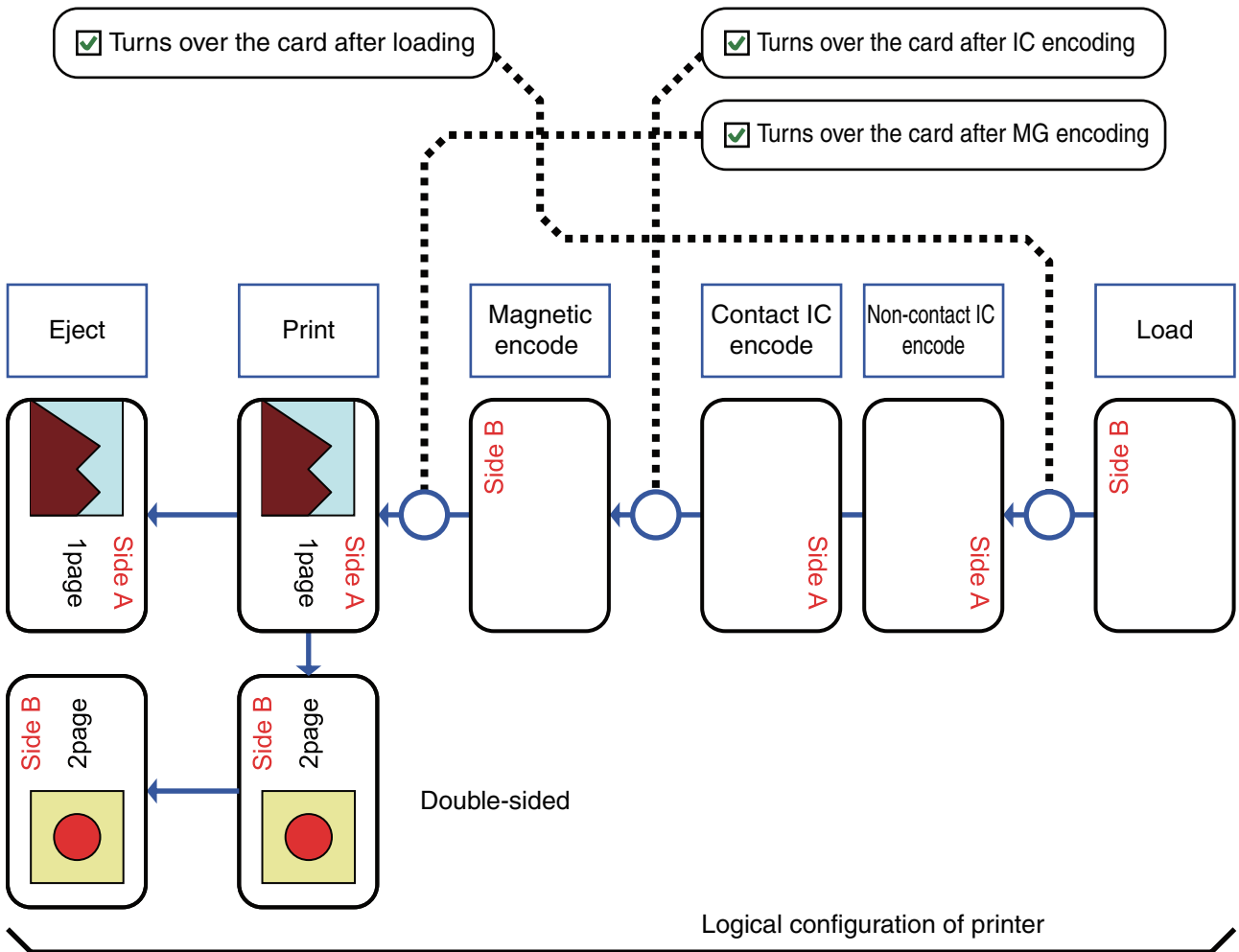
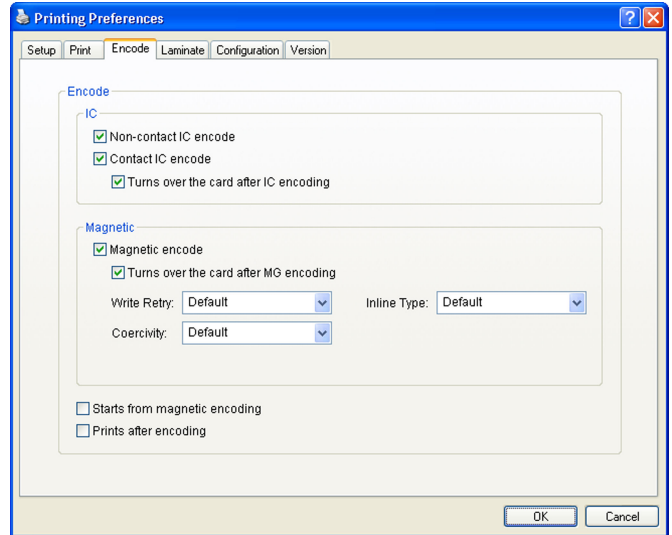
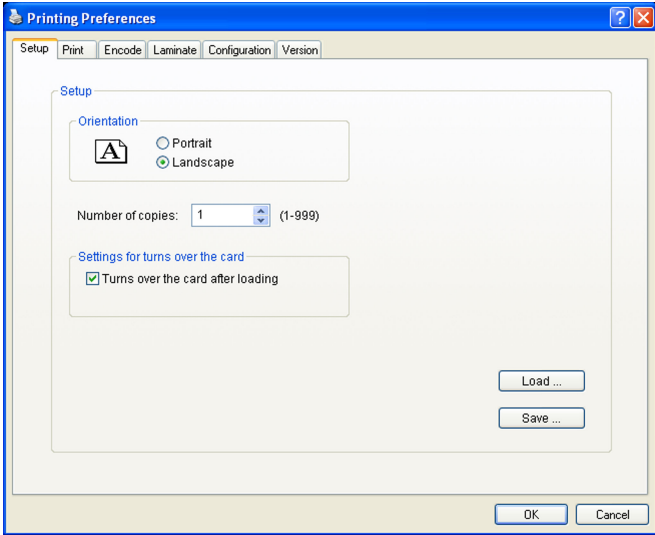

Port Monitor Settings

- "[Property] Tab" (☞ page 110)
- "[Version] Tab" (☞ page 110)

[Property] Tab

■ **USB connection**

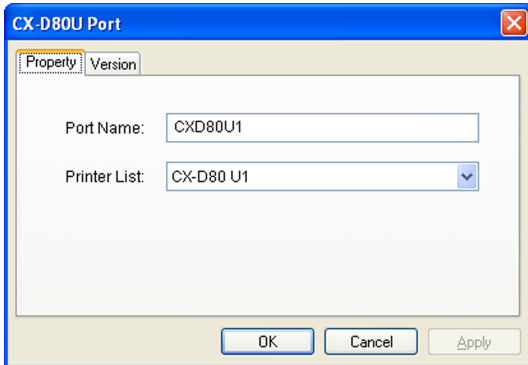

■ **Port Name**

Name of the port. You can enter a name up to 24 characters.

■ **Printer List**

List of connected printers. The selected printer is used for printing the card.

Cautions:

The setting is incorrect if the following message appears.

- No Device:
Printer is not found.
- No selection:
Last used printer is not found. A different printer is currently connected.

■ **Ethernet (LAN) connection**

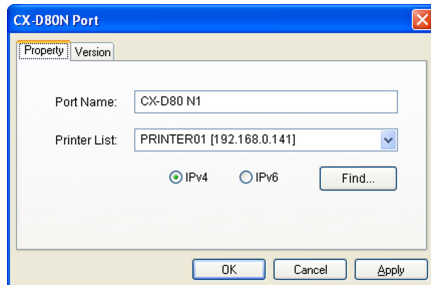

■ **Port Name**

Name of the port. You can enter a name up to 24 characters.

■ **Printer List**

List of connected printers. The selected printer is used for printing the card.

■ **IPv4**

When connecting using the IPv4 address, select [IPv4], followed by clicking [Find...] to search for the printer.

After clicking [IPv4], you can search for the printer by directly entering the IPv4 address in the [Printer List].

■ **IPv6**

When connecting using the IPv6 address, select [IPv6], followed by clicking [Find...] to search for the printer.

After clicking [IPv6], you can search for the printer by directly entering the IPv6 address in the [Printer List].

■ **[Find...] button**

Search for the printer after selecting [IPv4] or [IPv6]. The search results are displayed in the [Printer List].

Cautions:

The setting is incorrect if the following message appears.

- No Device:
Printer is not found.
- No selection:
Last used printer is not found. A different printer is currently connected.

[Version] Tab

Displays the version and copyright information.

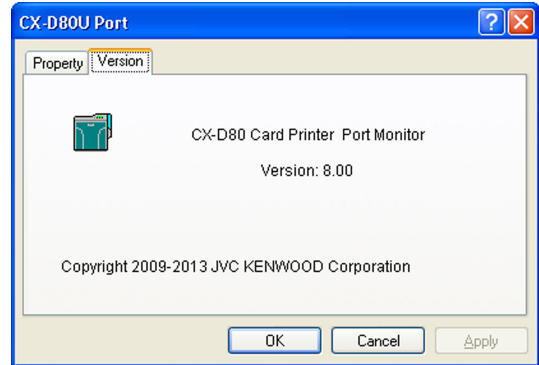

Status Monitor Settings

■ What is status monitor?

The status monitor is software for displaying the printer status as well as specifying various printer settings.

Cautions:

- The printer driver needs to be installed on the computer. You can install the printer driver using the CD-ROM supplied with the printer.
- Use the status monitor with the power of the printer turned on.

■ "Executing the status monitor" (☞ page 111)

■ "Screen Configuration" (☞ page 112)

- "[Printer Status] Tab" (☞ page 112)
- "[Printer Setting] Tab" (☞ page 114)
- "[Retransfer] Tab" (☞ page 115)
- "[Bend Remedy] Tab" (☞ page 116)
- "[Media Setting] Tab" (☞ page 116)
- "[Property] Tab" (☞ page 117)
- "[Printer Select] Tab" (☞ page 118)
- "[Security Lock] Tab" (☞ page 121)
- "[Others] Tab" (☞ page 121)

Executing the status monitor

You can run the status monitor using the following methods.

- Run using the shortcut on the Desktop display (if the icon is created during installation).
- Run from the Start menu (if a shortcut icon is created during installation).
- Run directly from the installed folder of the program.

Cautions:

- When a user logs in with administrator authority (Administrators group), the printer settings can be specified on the status monitor.
- When a user logs in without administrator authority and all the administrator setting items are disabled, the printer settings appear in the read-only mode on the status monitor and cannot be specified.

The caution screen appears.

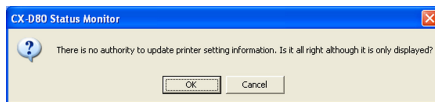

- When a user logs in without administrator authority and the administrator setting items are enabled, the printer settings can be specified on the status monitor.

The caution screen appears.

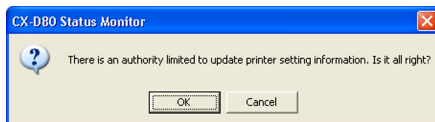

■ Windows XP

Cautions:

- If a [Windows Security Alert] screen appears upon starting up the status monitor, click [Unblock].
The status monitor will fail to function properly if you click on buttons other than [Unblock].



■ Windows Vista / Windows 7 / Windows 8

Selecting [Run as administrator...] enables you to run the status monitor as a user with administrator authority. Double-clicking the icon of the status monitor or selecting [Open] runs the status monitor as a user without administrator authority.

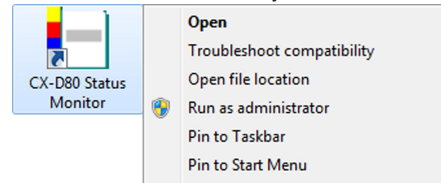

Memo:

- Even if a user is logged on with the administrator account, the user may be regarded as one without administrator authority when running the status monitor.

Cautions:

- If a [Windows Security Alert] screen appears upon starting up the status monitor, click [Allow access] or [Unblock].
The status monitor will fail to function properly if you click on [Cancel] or [Keep blocking].



Screen Configuration

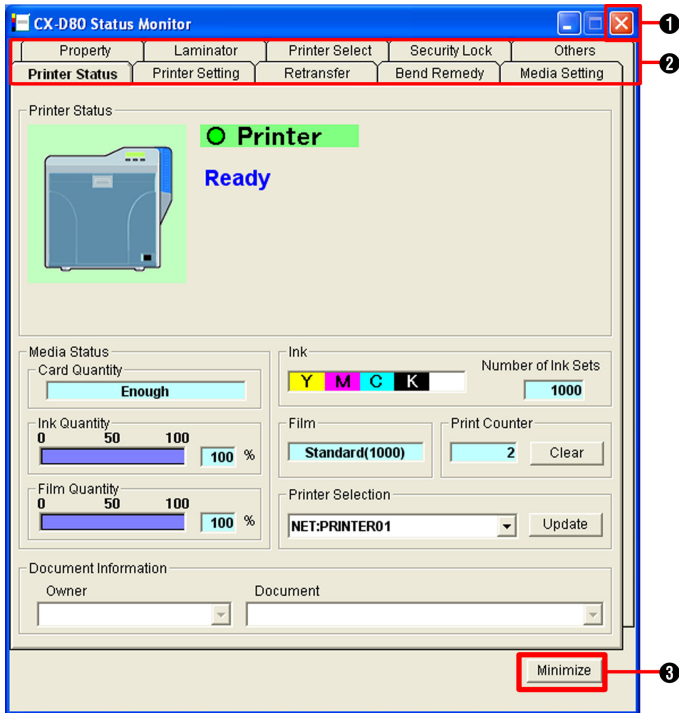

1 Close button

Closes the status monitor.

2 Screen selection tabs

Use these to switch to the following screens.

● Printer Status

Displays the printer's status.

● Printer Setting

For displaying and specifying the printer's print settings.
For displaying and specifying the printer's device settings.

● Retransfer

For displaying and specifying the conditions during retransfer to the card.

● Bend Remedy

For displaying and specifying the conditions during bend remedy of the card.

● Media Setting

Displays the status of the ink ribbon.
For setting the card and retransfer film.

● Property

Displays the device configuration.
Displays the firmware version.
Displays the counter value.

● Printer Select

For selecting a printer.
For displaying and setting the network connection status.

● Security Lock

For displaying and setting the security lock status.

● Others

For performing test prints.
For downloading the firmware.

3 Minimize button

Minimizes the status monitor to an icon. The icon is displayed in the taskbar.

[Printer Status] Tab

Displays the printer's status. Information on the screen is automatically updated at regular intervals.

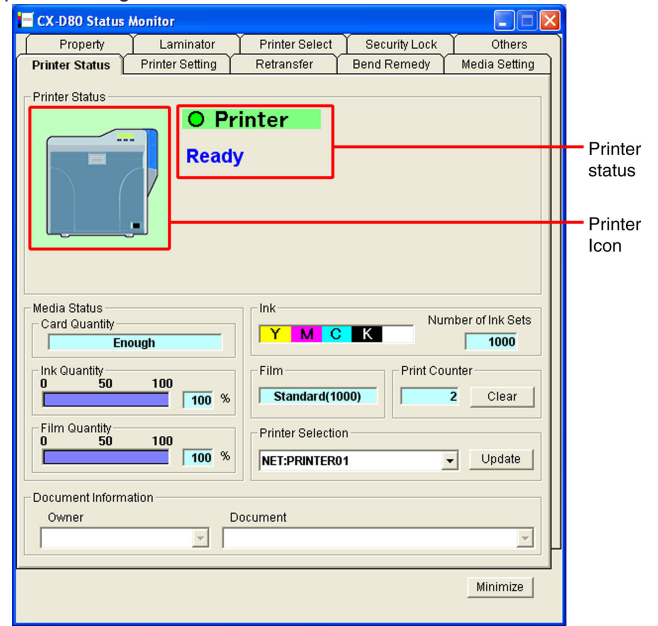

Printer status
Printer Icon

Printer Status

- Ready mode. The printer is ready to start printing.

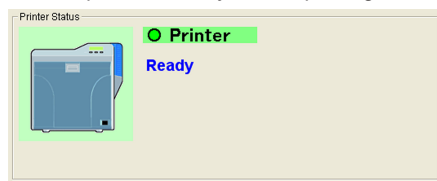

- Cleaning of the card feed roller and heating roller is required.

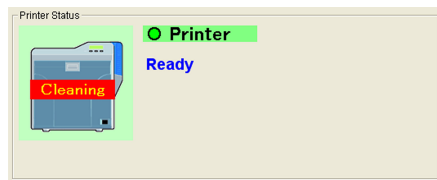

"Card Feed Roller/Heating Roller" (page 37)

- The printer is busy.

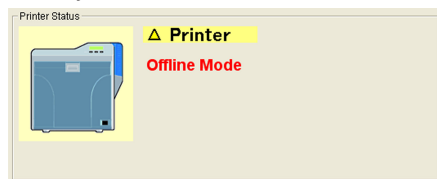

- Failure has occurred. The error code and description of the failure are displayed. In the example below, "0102D000" is the error code.

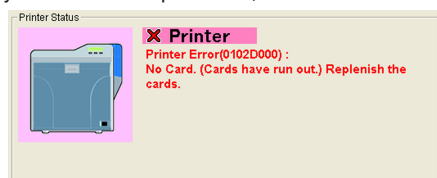

For more details, refer to "List of Error Codes" (page 125) .

■ Printer icons

The icon on the left is displayed when the printer is functioning normally. After printing more than 1000 cards since the last cleaning, it changes to the icon display shown on the right.

When the right icon appears, perform procedures in "Card Feed Roller/Heating Roller" (☞ page 37) under "Maintenance".



[Under Normal Circumstances]



[When Roller Cleaning is Required]

■ List of Status Display Messages

Status Display Message	Description
Printer is not found.	The power of the printer is not turned on, or the computer is not properly connected to the printer.
Ready	The printer is in the ready mode. The printer is ready to start printing cards.
Initializing	Printer initializing. The printer switches to the Ready mode after initialization is complete.
Offline Mode	The printer is in the setting mode, or roller cleaning is in progress. When this is complete, the printer switches to the Ready mode.
Preheating	Preheating of the heating roller is in progress. The printer switches to the Ready mode upon reaching an appropriate temperature.
Heating	Adjusting the heating roller to the preset temperature.
Card Loading	The printer is printing cards. Indicates the operating status when the printer is printing cards. After card printing is complete, the printer returns to the Ready mode.
Card Transporting	
No-Contact IC Encoding	
Contact IC Encoding	
MG Encoding	
Printing	
Retransfer	
Power Saving	

■ Media Status

Displays the remaining space on the media.

■ Card Quantity

Displays the remaining card quantity as [Enough] or [None].

Memo:

- If [None] is displayed, replenish the cards accordingly. For more details, refer to "Cards have run out" (☞ page 31) under "Adjusting the Printer Settings".

■ Ink Quantity

Displays the remaining ink ribbon quantity in percentage in 50 different levels.

Cautions:

- The remaining quantity is an estimated value. Differences may occur depending on the usage as well as media type.

■ Film Quantity

Displays the remaining retransfer film quantity in percentage in 10 different levels.

Cautions:

- The remaining quantity is an estimated value. Differences may occur depending on the usage as well as media type.

■ Ink

Displays the information on the loaded ink ribbon. The print counter appears blank if the ink ribbon is not correctly recognized. You may not be able to control the ink ribbon properly in this case. Check to ensure that the ink ribbon is properly installed. For more details, refer to "Installing the Ink Ribbon" (☞ page 60) under "Printing Media".

■ Film

Displays the type of retransfer film loaded.

■ Print Counter

Displays the total number of cards that are correctly printed. Press the [Clear] button to reset the print counter to 0.

■ Printer Selection

You can switch to the relevant printer when multiple printers are connected to a single computer. If the printer is not found or if you want to change the search criteria, refer to "Searching a printer" (☞ page 118) in the "[Printer Select] Tab".

Memo:

- Pressing the [Update] button searches for a connected printer and updates the printer in the list box.
- Selecting a printer from the pull-down menu switches the display to the current status of the selected printer.

■ Document Information

When printing from the printer driver, the name of the owner and document are displayed.

[Printer Setting] Tab

For specifying the printer settings.
Make sure that you take down the set values before making any changes.

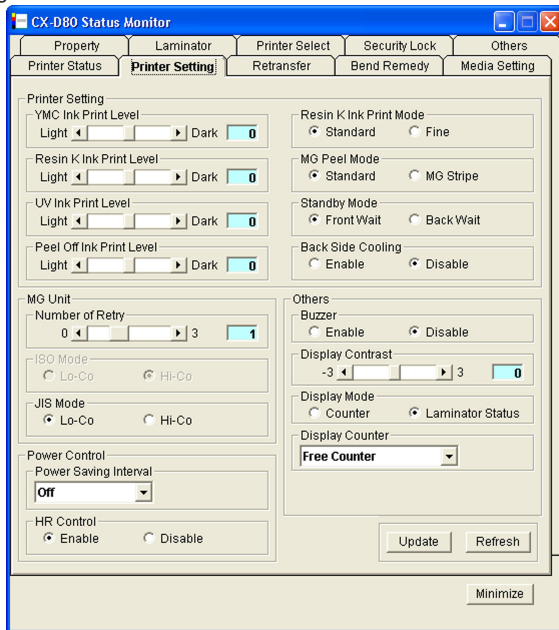

Printer Setting

YMC Ink Print Level

For setting the print density of the YMC ink.

Resin K Ink Print Level

For setting the print density of the Resin K ink.

UV Ink Print Level

For setting the print density of the UV ink.

Peel Off Ink Print Level

For setting the print density of the peel-off ink.

Resin K Ink Print Mode

For setting the print quality of the Resin K ink.
Selecting [Fine] enhances the printing quality, but slows down the printing speed.

MG Peel Mode

When a magnetic encoder unit is installed, selecting [MG Stripe] optimizes the peeling operation of retransfer films for magnetic stripe cards.

Standby Mode

Specify a position when a laminator is connected.
This is used for setting the standby position of the card during double-sided printing until the laminator is ready. The default setting is [Front Wait].

Back Side Cooling

This setting is only valid during double-sided printing.
Setting this item may help to reduce card bend during double-sided printing. However, the printing time may also be affected.

MG Unit

Number of Retry

For setting the maximum number of retries when writing to or reading of the magnetic stripe fails. The default value is [1].

ISO Mode

For specifying the coercivity of the ISO magnetic stripe. The default setting is [Hi-Co].

JIS Mode

For specifying the coercivity of the JIS magnetic stripe. The default setting is [Lo-Co].

Power Control

Power saving interval

The Power Saving mode helps to reduce power consumption when printing or operation is not performed over a specified time interval. Select whether to disable the Power Saving mode or specify the time interval before switching to the Power Save mode.

Selecting [Disable] deactivates the Power Saving mode. The default setting is [Disable].

HR Control

Switches to the standby mode by lowering the temperature of the retransfer heating roller when printing is not performed for 30 minutes or longer. The default setting is [Enable].

Others

Buzzer

For setting the warning sound when an error occurs or when the cards run out, as well as the confirmation sound upon pressing  on the operation panel of the printer unit.

The buzzer does not sound when [Disable] is selected. The default setting is [Enable].

Display Contrast

For setting the contrast of the printer's operation panel display.

Display Mode

For setting the information to be displayed on the printer's operation panel.

Display Counter

This is used for setting the type of counter to be displayed on the printer's operation panel.

For more details, refer to "Counter Types" (page 25) under "Setting Using the Operation Panel".

[Update] button

For applying changes made using the slide bar or radio buttons to the printer settings.

[Refresh] button

Displays the printer settings on the screen.

[Retransfer] Tab

The retransfer settings screen enables you to set the conditions of retransfer to the card.

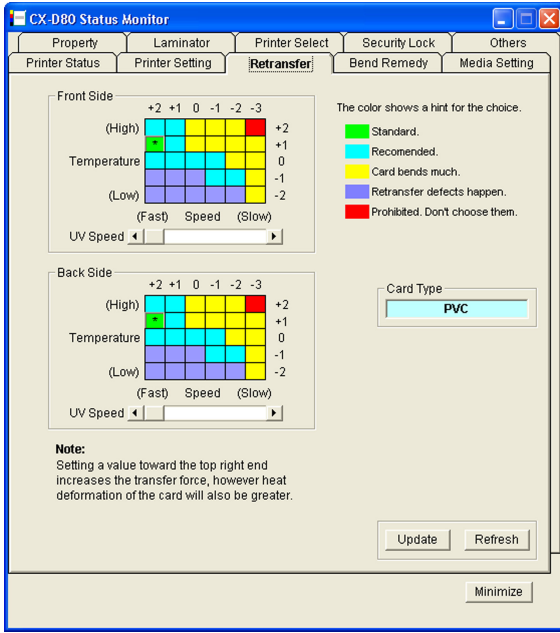

■ Card Type

The appropriate value varies according to the type of card used. You can change the card type in the [Media Setting] Tab. For more details, refer to "Card Type" (page 116) in the "[Media Setting] Tab".

■ [Update] button

Applies the selected value to the printer.





■ [Refresh] button

Displays the printer settings on the screen.

■ Front/Back side settings

■ Setting procedures

- The vertical axis shown in the setting area indicates the retransfer temperature, and the horizontal axis represents the retransfer speed.
- Click on the corresponding square to change the value. The selected value is indicated by [*].
- Setting a value toward the top right end increases the transfer force. However, the stronger heat also increases the deformation of the card.
- The colors below serve as a rough indicator for selection.

Color	Description
	Green Standard value.
	Light Blue Appropriate range. Recommended range when selecting a value other than the standard value.
	Yellow Card bend increases.
	Blue Retransfer defect may occur.
	Red Do not select these values.

Cautions:

- The different colors serve as a rough guide. The optimal value varies according to the card type as well as the environment in which the printer is used. Adjust the setting according to the actual environment.
- It may take a while for printing to start when the retransfer temperature is changed.
- There is only one standard retransfer temperature. Altering the retransfer temperature on one side changes the temperature on the other side.
- The range of optimal values varies according to the [Card Type]. You can change the card type in the [Media Setting] Tab.
- If the card type varies across printers, set the card type to use accordingly. The color of the setting area varies according to the card type in use.

■ UV Speed

Setting for printing the retransfer film in two panels when UV ink is used. It is used to set the speed of the retransfer heating roller during retransfer of the UV ink. This setting helps to increase the retransfer speed without affecting the quality of the UV print.

[Bend Remedy] Tab

The bend remedy settings screen enables you to set the conditions for the card's bend remedy.

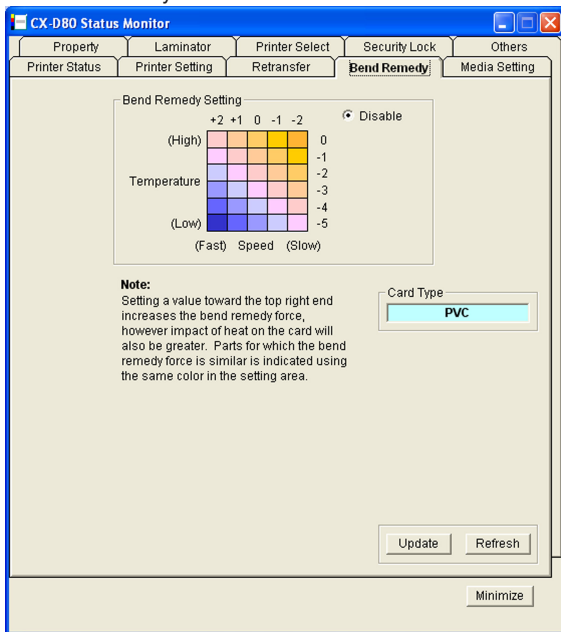

■ Bend Remedy Setting

■ Setting procedures

- The vertical axis in the setting area indicates the bend remedy temperature, and the horizontal axis represents the bend remedy speed.
- Click on the corresponding square to change the value. The selected value is indicated by [*].
- Setting a value toward the top right end increases the bend remedy force. However, the stronger heat may have a greater impact on the card.
- Parts for which the bend remedy force is similar is indicated using the same color in the setting area.
- To disable bend remedy, select the [Disable] button. [Disable] is selected in the default setting.

■ Cautions:

- The different colors serve as a rough guide. The optimal value varies according to the card type as well as the environment in which the printer is used. Adjust the setting according to the actual environment.
- Bend remedy is effective when printing on only one side. Performing double-sided printing with a high bend remedy temperature may cause the card to deform significantly. As such, select the [Disable] button during double-sided printing.
- When the [Disable] radio button is deselected, the printer switches to and remains in the preheating mode (for approximately 10 minutes) until the bendy remedy heating roller's temperature has gone down. This is not a malfunction. Wait for the printer to switch to the Ready mode.
- When the [Disable] button is selected, the speed is automatically set to the maximum value of [+2].
- The stronger the bend remedy force, the less glossy the surface of the remedy side will be.

■ Card Type

The appropriate value varies according to the type of card used. You can change the card type in the [Media Setting] Tab. For more details, refer to "Card Type" (☞ page 116) in the "[Media Setting] Tab".

■ [Update] button

Applies the selected value to the printer.

■ [Refresh] button

Displays the printer settings on the screen.

[Media Setting] Tab

This is used for specifying the printing media settings.

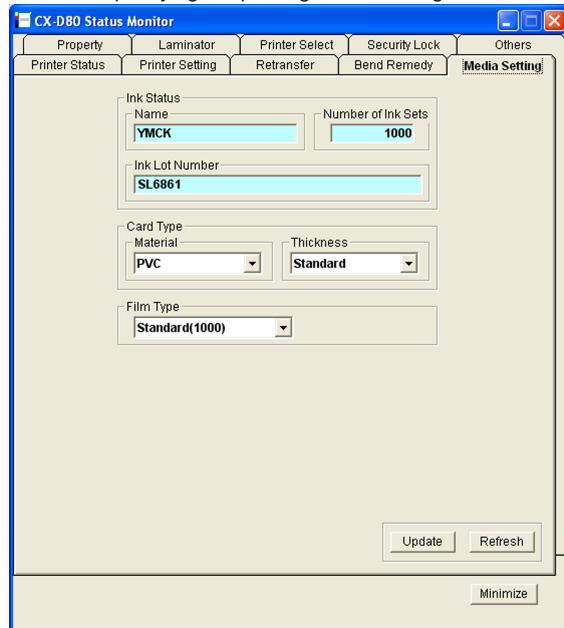

■ Ink Status

■ Name

Displays the name of the loaded ink ribbon. A message indicating the cause appears when the ink ribbon cannot be recognized. For more details, refer to "Ink ribbon cannot be recognized" (☞ page 117) .

■ Number of Ink Sets

Displays the specification of the loaded ink ribbon in the number of images. This is not an indication of the current ink level.

■ Ink Lot Number

Displays the lot number of the loaded ink ribbon.

■ Card Type

■ Material

For selecting [PVC], [PET-G] or [HR-PET-G] as the card material. An optimal value for the retransfer speed and temperature settings is displayed according to the selected card. The optimal value of other materials will not be displayed.

■ [HR-PET-G] : Heat-resistant PET-G

"[Retransfer] Tab" (☞ page 115)

"[Bend Remedy] Tab" (☞ page 116)

■ Thickness

For setting the discharge rate to the card stacker in accordance with the card thickness. Set this to [Standard] during normal use.

■ Cautions:

- To use cards of different thickness, refer to "Adjusting Card Thickness" and adjust accordingly. "Adjusting card thickness" (☞ page 63)
- If the material of the cards to be used varies across printers, set the card material separately.

Film Type

Displays the specification of the loaded retransfer film in the number of images. This is not an indication of the current film level.

[Update] button

Applies the selected value to the printer.

[Refresh] button

Displays the printer settings on the screen.

Ink ribbon cannot be recognized
 If the ink ribbon cannot be recognized, the cause for this problem is indicated in the [Name] field under [Ink Status].

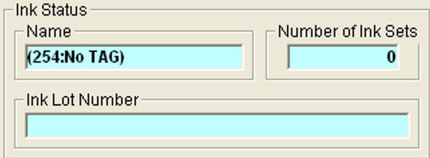

Message	Cause and Action During Ink Recognition Error
(252:Invalid TAG Data)	The TAG record data adhered to the ink ribbon is incorrect. Replace the ink ribbon and try again.
(253:Defective TAG)	Unable to establish communication with the TAG adhered to the ink ribbon. Replace the ink ribbon and try again.
(254:No TAG)	Unable to read the TAG adhered to the ink ribbon. Check to ensure that the ink ribbon is correctly set.
(255:Defective R/W)	Printer TAG reader error. The printer needs to be repaired.

[Property] Tab

This tab displays the device configuration.

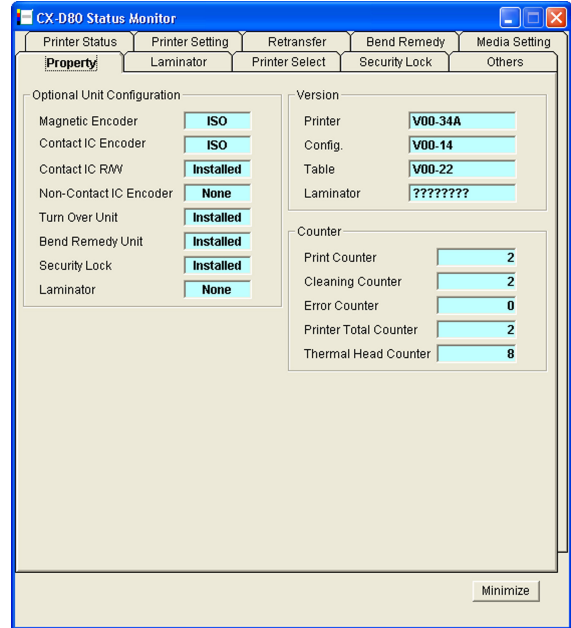

Optional Unit Configuration

Displays the configuration of optional devices.

Cautions:

- If a setting other than [None] is displayed for the contact or non-contact IC encoder, it means the configuration supports installation of an IC encoder, and is not an indication that an IC encoder has been installed.
- Consult our authorized dealers on how to install the IC encoder.

Version

Displays the firmware version of the printer and laminator. If a laminator is not connected, [????????] will appear.

Counter

Displays the counter value of the printer.

Print Counter (free counter)

Displays the total number of cards that are correctly printed.

Memo:

- Clicking [Clear] for "Print Counter" in the [Printer Status] Tab resets the counter value of the [Print Counter] to 0.

"Print Counter" (page 113)

Cleaning Counter

Displays the number of cards that are correctly printed after the last cleaning.

Error Counter

Displays the number of cards that are not correctly printed.

Memo:

- Clicking [Clear] for "Print Counter" in the [Printer Status] Tab resets the counter value of the [Error Counter] to 0.

"Print Counter" (page 113)

Printer Total Counter (total counter)

Displays the number of cards that are correctly printed.

Thermal Head (head counter)

Displays the number of print ink panels for the thermal head. For example, when printing on a single side using all YMCK inks, 4 are added to each card.

[Printer Select] Tab

This tab is used for selecting a printer and specifying the network settings.

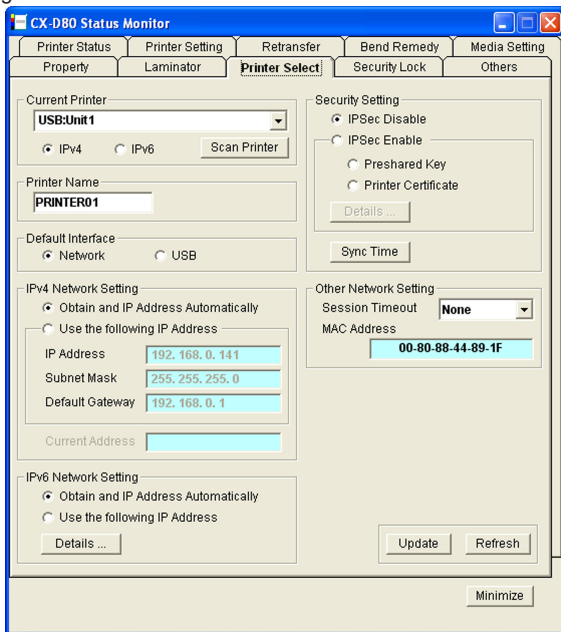

■ Current Printer

■ Selecting a printer

Selecting a printer from the pull-down menu switches the display to the current status of the selected printer.

■ Searching a printer

Clicking the [Scan Printer] button displays the search results in the pull-down menu.

■ Searching USB connection printers

- ① Click [Scan Printer].
- ② Printer search is performed, and the result is displayed in the pull-down menu.

■ Searching printers for the IPv4 address

- ① Select [IPv4], and click [Scan Printer].
- ② Printer search is performed, and the result is displayed in the pull-down menu.

■ Searching printers for the IPv6 address

- ① Select [IPv6], and click [Scan Printer].
- ② Printer search is performed, and the result is displayed in the pull-down menu.

Cautions:

- The printer connected via Ethernet (LAN) may not be searchable if IPsec is enabled. In this case, search the printer again after registering the printer.

■ Registering a printer

You can enter the IP address in the pull-down menu to register the printer for the IP address in the menu.

Memo:

- Registered IP addresses will be stored in the memory even after exiting the status monitor.
- The printer cannot be registered if the IP address format is incorrect.

■ Registering printers for the IPv4 address

- ① Select [IPv4], and enter the IPv4 address in the pull-down menu.
- ② Click [Scan Printer] to display the registration confirmation dialog box.
- ③ Click [OK] to register the printer for the entered IP address to the pull-down menu.

■ Registering printers for the IPv6 address

- ① Select [IPv6], and enter the IPv6 address in the pull-down menu.
- ② Click [Scan Printer] to display the registration confirmation dialog box.
- ③ Click [OK] to register the printer for the entered IP address to the pull-down menu.

■ Deleting a printer

You can select a printer and delete it from the pull-down menu.

■ Deleting printers for the IPv4 address

- ① Select [IPv4], followed by selecting the printer to delete from the pull-down menu.
- ② Select [Delete Printer] from the pull-down menu. A deletion confirmation dialog box appears.
- ③ Click [OK] to delete the selected printer from the pull-down menu.

■ Deleting printers for the IPv6 address

- ① Select [IPv6], followed by selecting the printer to delete from the pull-down menu.
- ② Select [Delete Printer] from the pull-down menu. A deletion confirmation dialog box appears.
- ③ Click [OK] to delete the selected printer from the pull-down menu.

■ Printer Name

For setting the name of the selected printer.

You can input up to 10 ASCII characters. Symbol characters may not be displayed on the operation panel.

■ Default Interface

For setting the interface during startup. For Ethernet (LAN) connection, the settings are displayed in the read-only mode, and they cannot be changed.

Cautions:

- Regardless of the default interface setting, priority is given to USB if a USB cable is connected.
- To assign priority to the USB connection, enable the operation of the computer and USB hub.

■ Network

Enables you to print via the Ethernet (LAN) connection.

■ USB

Enables you to print via the USB connection.

■ IPv4 Network Setting

For setting items related to Ethernet (LAN). For Ethernet (LAN) connection, the settings are displayed in the read-only mode, and they cannot be changed.

Cautions:

- Determine the network setting items according to the instructions of the network administrator for the location where the printer unit is installed.
- Other network devices may be affected if the network setting is incorrect.
- When only USB connection is used, there is no need to specify the network setting.

■ Obtain and IP Address Automatically

Values such as the IPv4 address can be automatically acquired from the DHCPv4 server.
If the DHCPv4 server is not found, settings in the [Use the following IP Address] will be applied.

Memo:

- For values automatically acquired from the DHCPv4 server, only the IP address is displayed in [Current Address].
- Values such as the IP address may change regularly according to the DHCPv4 server settings.
- If you want to use a static IP address for application software such as the printer driver, set to [Use the following IP Address].

■ Use the following IP Address

Uses a static IP address. Set the [IP Address], [Subnet Mask], and [Default Gateway].

■ Current Address

Displays the IPv4 address.

■ IPv6 Network Setting

For setting items related to Ethernet (LAN). For Ethernet (LAN) connection, the settings are displayed in the read-only mode, and they cannot be changed.

Cautions:

- Determine the network setting items according to the instructions of the network administrator for the location where the printer unit is installed.
- Other network devices may be affected if the network setting is incorrect.
- When only USB connection is used, there is no need to specify the network setting.

■ Obtain and IP Address Automatically

Values such as the IPv6 address can be automatically acquired from the DHCPv6 server.
If the DHCPv6 server is not found, settings in the [Use the following IP Address] will be applied.

Memo:

- For values automatically acquired from the DHCPv6 server, only the IP address is displayed when you click [Details...].
- Values such as the IP address may change regularly according to the DHCPv6 server settings.
- If you want to use a static IP address for application software such as the printer driver, set to [Use the following IP Address].

■ Use the following IP Address

You can specify a static IP address as follows.
Click [Details...] to set [IPv6 Address], [Default Gateway], and [Subnet Prefix Length].

■ [Details...] button
Displays the [IPv6 Setting] screen.
Set [IPv6 Address], [Default Gateway], and [Subnet Prefix Length].

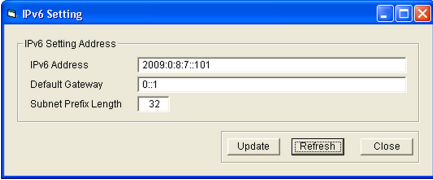

■ Security Setting

For setting items related to the IPSec of Ethernet (LAN). The settings are displayed in the read-only mode when connection is established via Ethernet (LAN). The settings cannot be changed.

Cautions:

- Determine the setting items according to the instructions of the network administrator for the location where the printer unit is installed.
- Encrypted communication cannot be established if the security settings are incorrect.
- When only USB connection is used, there is no need to specify the security settings. USB connection does not support encrypted communication.
- It is not possible to specify the security settings for the printer unit without using a USB connection.
- For details on downloaded files to be used for the security settings, refer to "IPSec".

"IPSec" (page 87)

■ IPSec Disable

Communication is enabled only when IPSec is not used. The default setting is [IPSec Disable].

■ IPSec Enable

Communication is established using IPSec. After [Details...] setting is complete, [Preshared Key] or [Printer Certificate] is selected.

Memo:

- Selecting [IPSec Enable] enables [Details...].
- Clicking the [Preshared Key] or [Printer Certificate] button does not enable you to change the settings.

■ Encrypted communication by IPSec

Refer to the table below on whether encrypted communication by IPSec can be performed.

Printer Settings	IPSec Policy of PC		
	Security Required	Request for Security	Not Protected
"Disable IPSec"	Communication disabled	Normal communication	Normal communication
"Enable IPSec" (When authentication fails)	Communication disabled		
"Enable IPSec" (When authentication is successful)	Encrypted communication	Encrypted communication	Communication disabled

- [Details...] button
Displays the [IPSec Setting] screen.
Downloads files required for IPSec authentication to the printer.

■ File settings required for preshared key authentication

A preshared key file is required for preshared key authentication.

- 1 Select [Preshared Key] for [Download Type], and click [Select...]

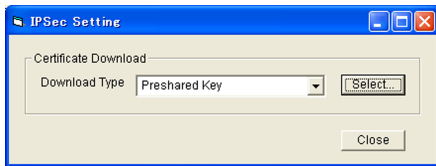

- 2 Select a preshared key file, and click [Write]

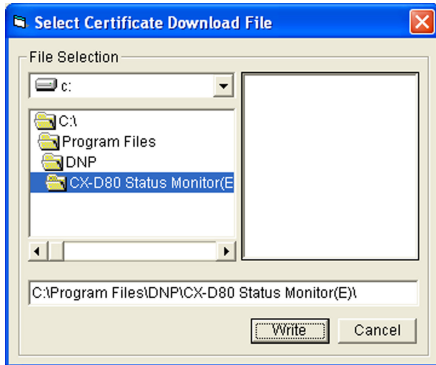

- 3 Click the [Close] button on the [IPsec Setting] screen
 - IPsec setting for the printer is complete after closing the screen.

■ File settings required for certificate authentication

Certificate files for the printer as well as from the certification authority are required for certificate authentication.

- 1 Select [Printer Certificate] for [Download Type], and click [Select...]

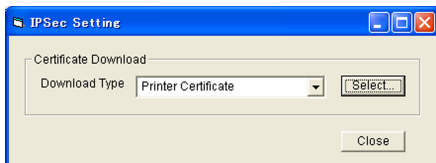

- 2 Select a printer certificate file, and click [Write]

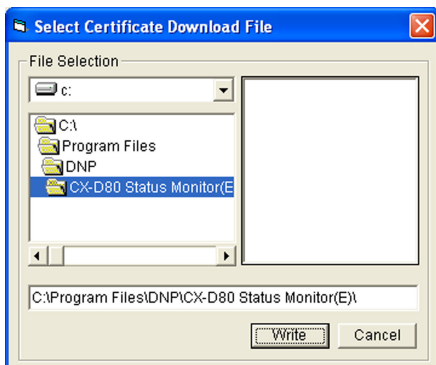

- 3 Enter the password for the printer certificate file, and click [OK]

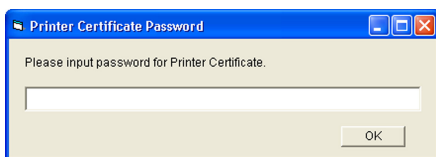

- 4 Select [CA Certificate] for [Download Type], and click [Select...]

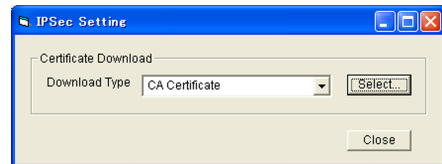

- 5 Select a certification authority certificate file, and click [Write]

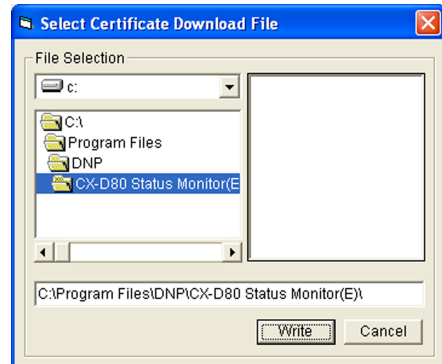

- 6 Click the [Close] button on the [IPsec Setting] screen
 - IPsec setting for the printer is complete after closing the screen.

■ Sync Time

clicking the [Sync Time] button sends out the current time of the PC to the printer. You can specify this setting via USB or network connection.

■ Other Network Setting

■ Session Timeout

For setting the time interval before disconnecting automatically if there is no communication after printing connection is established. The default setting is [None].

■ MAC Address

Displays the MAC address of the printer.

■ [Update] button

Applies the selected value to the printer.

■ [Refresh] button

Displays the printer settings on the screen.

[Security Lock] Tab

For displaying and setting the security lock status.

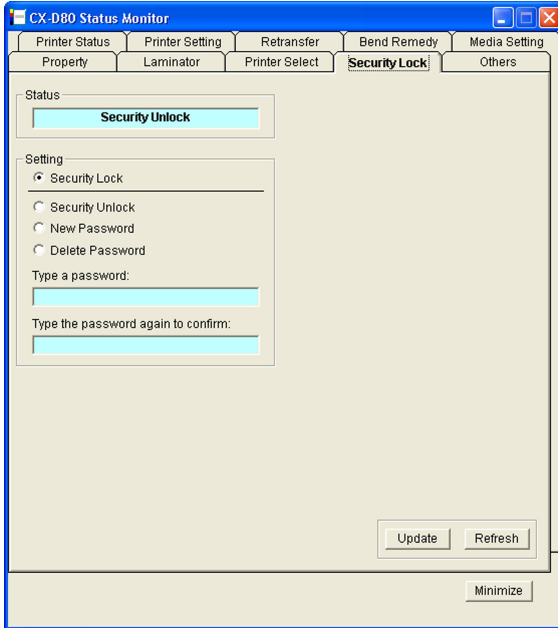

■ Status

Displays the current security lock status.

■ Setting

■ [Security Lock]

Select [Security Lock], followed by clicking [Update] to activate the security lock.
The security lock cannot be activated if a password is not specified.

■ [Security Unlock]

Select [Security Unlock], enter the password in [Type a password], followed by clicking [Update] to deactivate the security lock.

■ [New Password]

Select [New Password], and enter a password of up to eight characters.
Enter the same password for [Type a password] and [Type the password again to confirm], followed by clicking [Update] to set the password.

■ [Delete Password]

Select [Delete password], enter the password in [Type a password], followed by clicking [Update] to delete the password.

Memo:

- To change the password, you have to delete it and register a new password again.
- If you forgot the password, please consult our authorized dealer or the servicing personnel.
- There is no relation between the password for the status monitor and the security number that is input on the operation panel of the printer. You can specify different values for these items.
The password for the status monitor supports alphanumeric characters.

"Security Lock" (☞ page 20)

■ [Update] button

Applies the selected value to the printer.

■ [Refresh] button

Displays the printer settings on the screen.

[Others] Tab

This tab enables you to perform test prints and download the firmware.

Memo:

- For printers connected via Ethernet (LAN), the test print and firmware download items are not displayed.

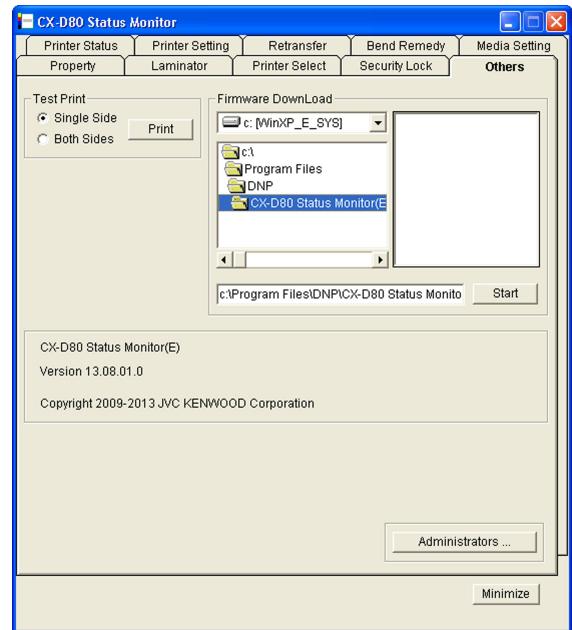

■ Test Print

Test print uses the printer's self-diagnosis function without making use of the printer driver. You can use it to verify whether the printer is functioning correctly.

1 Select [Single Side] or [Both Sides], and click [Print]

- Test print starts. The built-in standard color pattern of the printer is printed on a card.

■ Firmware DownLoad

Updates the printer's firmware.

1 Perform the "Firmware Update" procedure on the operation panel of the printer

"Firmware Update" (☞ page 24)

2 Select a file, and click [Start]

3 Follow the instructions on the screen

Cautions:

- For details on update of the printer's firmware, please consult the servicing personnel or our authorized dealers.
- The printer may not start up if update of the firmware fails.

■ Software

Displays the version and copyright information.

■ [Administrators...] button

Opens the [Administrators] dialog box.
"[Administrators] Dialog Box" (☞ page 122)

Cautions:

- The [Administrators...] button displays only when the status monitor is run with administrator authority.
"Run as administrator" (☞ page 111)

[Administrators] Dialog Box

“Non-administrative user” can set [Printer Setting] etc. when the functions or tabs are checked in the [Administrators] dialog box.

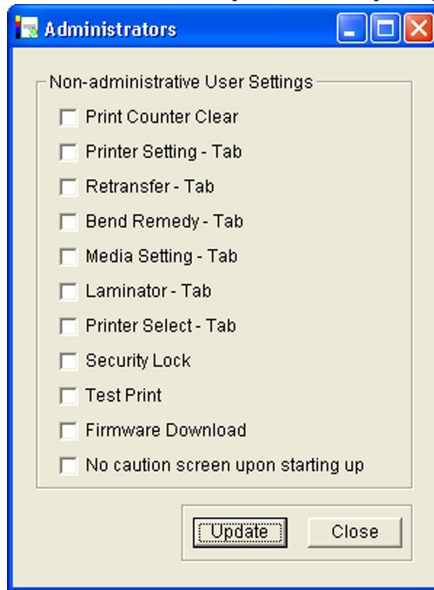

■ Non-administrative User Settings:

Selected functions can be set by checking the checkbox.

■ Print Counter Clear

The [Clear] button of the print counter in the [Printer Status] Tab enables.

■ Printer Setting - Tab

The settings in the [Printer Setting] Tab enables.

■ Retransfer - Tab

The settings in the [Retransfer] Tab enables.

■ Bend Remedy - Tab

The settings in the [Bend Remedy] Tab enables.

■ Media Setting - Tab

The settings in the [Media Setting] Tab enables.

■ Laminator - Tab

The settings in the [Laminator] Tab enables.

■ Printer Select - Tab

The settings in the [Printer Select] Tab enables.

■ Security Lock

The settings in the [Security Lock] Tab enables.

■ Test Print

The [Test Print] in the [Others] Tab enables.

■ Firmware DownLoad

The [Firmware DownLoad] in the [Others] Tab enables.

■ No caution screen upon starting up

When a user without administrator authority runs the status monitor, the caution screen will not be displayed initially.

"Executing the status monitor" (☞ page 111)

Cautions:

- When specifying as a user without administrator authority, the “Card Type”, “Registering for the IPv4 address” and “Registering for the IPv6 address” items are not saved in the status monitor. To save the settings, log in as a user with administrator authority.

■ [Update] button

Applies the selected value to the status monitor.

■ [Close] button

Closes the [Administrators] dialog box.

Inline Encoding

- "Inline Encoding Format" (☞ page 123)
- "Character Code List" (☞ page 124)

Inline Encoding Format

- Inline encoding can be performed by enabling the settings in the [Encode] tab of the printer driver settings.
- "[Encode] Tab" (☞ page 98)
- Encoding data can be sent to the printer through the printer driver using the special character strings (prefixes) described below. This function is called "inline encoding".
- Set the methods of inline encoding in the "Inline Encoding" of the [Encode] tab.
- This method functions for only ISO Magnetic encoding data. The default encoding is encoded without the ISO Magnetic encoding.

Cautions:

- Character strings may not be recognized as encoding data if they are processed as graphics, such as screen captures. Processing of character strings is dependent on the application software in use.
- Enter the inline encoding character strings in the first image of each card to be printed.

Default encoding

- Adding a prefix (tilde (~), ?, or numeric characters) at the beginning of a text string enables the string to be recognized as encoding data. Character strings including prefixes are not printed on the card when they are recognized as encoding data.

No.	Prefix (half-width character string)	Text string following prefix ①	Usable character code list ②	Max. string length ③
1	~ ?0	String denotes JIS2 magnetic encoding data. ④	7-unit code	69
2	~ ?1	String denotes ISO track 1 magnetic encoding data.	6-unit code	76
3	~ ?2	String denotes ISO track 2 magnetic encoding data.	4-unit code	37
4	~ ?3	String denotes ISO track 3 magnetic encoding data.	4-unit code	104
5	~ ?4	Contact IC encoding data.	8-unit code	32760
6	~ ?5	Non-contact IC encoding data.	8-unit code	32760
7	~ ?6	String denotes ISO track 1 magnetic encoding data.	7-unit code	69
8	~ ?7	String denotes ISO track 3 magnetic encoding data.	7-unit code	69
9	~ ?8	String denotes ISO track 1 magnetic encoding data (AAMVA standard).	6-unit code	79
10	~ ?9	String denotes ISO track 3 magnetic encoding data (AAMVA standard).	6-unit code	79

- ① Make sure that the string is not broken, and use the same font.
- ② Encoding cannot be performed correctly if characters that do not conform with the usable character code list are used.
- ③ The maximum string length is the number of characters including control codes and excluding prefixes.
- ④ Half-width katakana characters can be used. For a list of usable characters, refer to the Katakana Character Code List.

Example

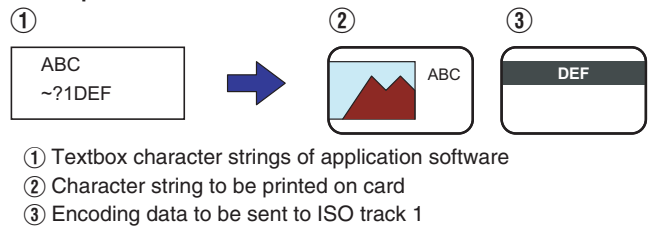

Type B encoding

- Adding a prefix (tilde (~), numeric characters or start sentinel) at the beginning of a text string enables the string to be recognized as encoding data. Character strings including prefixes are not printed on the card when they are recognized as encoding data.
- The start sentinel (Refer to the "Character Code List") determines the unit code.

"Character Code List" (☞ page 124)

- The end sentinel (Refer to the "Character Code List") is needed at the last of the character string.

"Character Code List" (☞ page 124)

No.	Prefix (half-width character string)	Text string following prefix ①	Usable character code list ②	Last character
1	~1 start sentinel	String denotes ISO track 1 magnetic encoding data.	6-unit code 7-unit code	End sentinel
2	~2 start sentinel	String denotes ISO track 2 magnetic encoding data.	4-unit code	End sentinel
3	~3 start sentinel	String denotes ISO track 3 magnetic encoding data.	4-unit code 6-unit code 7-unit code	End sentinel

- ① Make sure that the string is not broken, and use the same font.
- ② Encoding cannot be performed correctly if characters that do not conform with the usable character code list are used.

Type C encoding

- Adding a prefix (tilde (~), numeric characters or "=") at the beginning of a text string enables the string to be recognized as encoding data. Character strings including prefixes are not printed on the card when they are recognized as encoding data.

No.	Prefix (half-width character string)	Text string following prefix ①	Usable character code list ②	Max. string length ③
1	~1=	String denotes ISO track 1 magnetic encoding data.	6-unit code	76
2	~2=	String denotes ISO track 2 magnetic encoding data.	4-unit code	37
3	~3=	String denotes ISO track 3 magnetic encoding data.	4-unit code	104

- ① Make sure that the string is not broken, and use the same font.
- ② Encoding cannot be performed correctly if characters that do not conform with the usable character code list are used.
- ③ The maximum string length is the number of characters including control codes and excluding prefixes.

Character Code List

■ **ASCII character code list**

- Below is the list of usable ASCII character codes. Specify the text string to encode using the usable half-width characters for each of the unit codes.

					b7	0	0	0	0	1	1	1	1
					b6	0	0	1	1	0	0	1	1
					b5	0	1	0	1	0	1	0	1
b4	b3	b2	b1		0	1	2	3	4	5	6	7	
0	0	0	0	0			0	@	P	`	p		
0	0	0	1	1			!	1	A	Q	a	q	
0	0	1	0	2			"	2	B	R	b	r	
0	0	1	1	3			#	3	C	S	c	s	
0	1	0	0	4			\$	4	D	T	d	t	
0	1	0	1	5			%	5	E	U	e	u	
0	1	1	0	6			&	6	F	V	f	v	
0	1	1	1	7			'	7	G	W	g	w	
1	0	0	0	8			(8	H	X	h	x	
1	0	0	1	9)	9	I	Y	i	y	
1	0	1	0	A	LF		*	:	J	Z	j	z	
1	0	1	1	B			+	;	K	[k	{	
1	1	0	0	C			,	<	L	\	l		
1	1	0	1	D			-	=	M]	m	}	
1	1	1	0	E			.	>	N	^	n	~	
1	1	1	1	F			/	?	O	_	o	DEL	

- ① Range of usable text characters for 7-unit code
- ② Range of usable text characters for 6-unit code
- ③ Range of usable text characters for 4-unit code
- ④ Tilde character (Hexadecimal: 7E)

- The start sentinel and end sentinel listed below cannot be used in the encoding data.

Unit Code	Start Sentinel (Hexadecimal)	End Sentinel (Hexadecimal)
4-unit code	;	(3B) ? (3F)
6-unit code	%	(25) ? (3F)
7-unit code	DEL	(7F) DEL (7F)

List of Error Codes

Printer (Error Code:0x01000000-0x01040000)

No.	Error Code	Description	Actions (Reference Page No.)
1	0x0102D000	Cards have run out.	Replenish the cards. (☞ page 31)
		The card hopper is detached.	Install the card hopper. (☞ page 63)
2	0x0102D100	The printer door is open.	Close the door, and press Reset →  to reset the printer. (☞ page 22)
		The cleaning unit is detached.	Install the cleaning unit. (☞ page 35)
3	0x0102D300	The printer is busy.	-
	0x0102D400		
	0x0102D500		
4	0x0102DA00	Preheating is in progress.	Wait until preheating is complete.
5	0x0102DB00	Printer is initializing.	Wait until initialization is complete.
6	0x0102DC00	Offline testing is in progress.	Wait until the offline test is complete.
		Cleaning is in progress.	Wait until cleaning is complete.
7	0x0102DD00	Operation panel is currently in use.	-
		The printer is in the transport mode.	Cancel the transport mode. (☞ page 29)
8	0x0102DE00	The firmware cannot be downloaded.	Set the printer to the download mode. (☞ page 24)
9	0x0102FD00	The printer is in the Power Saving mode.	Resetting the printer temporarily cancels the Power Saving mode. (☞ page 22) The printer resets automatically when the printer driver is used to start printing.
10	0x0102FE00	Password authentication is not complete.	-
11	0x0102****	The printer is not ready.	-
12	0x01039000	Failure occurred during card loading.	Remove the card according to the procedure for the "Error Code: Jam (Hopper) 90". (☞ page 46)
13	0x01039100	Card jam near the card turn over unit.	Remove the card according to the procedure for the "Error Code: Jam(TurnOver) 91". (☞ page 47)
14	0x01039200	Card jam near the magnetic encoder.	Remove the card according to the procedure for the "Error Code: Jam (MG) 92". (☞ page 49)
15	0x01039300	Card jam near the card feed roller.	Remove the card according to the procedure for the "Error Code: Jam (Transfer) 93". (☞ page 50)
16	0x01039400	Card jam near the card outlet.	Remove the card according to the procedure for the "Error Code: Jam (Discharge) 94". (☞ page 51)
17	0x01039500	Card jam near the retransfer heating roller.	Remove the card according to the procedure for the "Error Code: Jam (Retran.) 95". (☞ page 52)
18	0x0103A100	Retransfer film is broken.	Repair the retransfer film. (☞ page 56)
		Retransfer film is not detected.	Install the retransfer film correctly. (☞ page 61)
19	0x0103A800	A writing error has occurred during magnetic encoder self-diagnosis.	Check the card specifications.
20	0x0103AD00	An error has occurred during magnetic encoding data writing.	
21	0x0103AE00	An error has occurred during magnetic encoding data reading.	
22	0x0103B000	An incorrect ink ribbon is installed.	Install a correct ink ribbon.
23	0x0103B100	Ink ribbon is broken.	Repair the ink ribbon. (☞ page 54)
		Ink ribbon is not detected.	Install the ink ribbon correctly. (☞ page 60)
24	0x0103****	A media error has occurred.	Check the card specifications.

Printer (Error Code:0x01040000-0x02000000)

No.	Error Code	Description	Actions (Reference Page No.)
25	0x01044400	A hardware error has occurred.	Turn off and on the power again. If the same problem recurs, turn off the power and consult our authorized dealers.
26	0x0104AB00	An error has occurred in the mechanical component of the magnetic encoder.	
27	0x0104AC00	A hardware error has occurred in the magnetic encoder.	
28	0x0104C100	A heating roller operation error has occurred.	
29	0x0104C200	The temperature of the bend remedy heating roller or retransfer heating roller is too high.	
30	0x0104C300	An internal 24v instantaneous interruption is detected.	
31	0x0104D800	A hardware error has occurred during initialization.	
32	0x0104F000	The temperature of the retransfer heating roller is too high.	
33	0x0104F100	The retransfer heating roller is faulty.	
34	0x0104F200	The thermistor of the retransfer heating roller is faulty.	
35	0x0104F300	The temperature of the bend remedy heating roller is too high.	
36	0x0104F400	The bend remedy unit is faulty.	
37	0x0104F500	The thermistor of the bend remedy heating roller is faulty.	
38	0x0104F600	The operating ambient temperature of the printer is too low.	
39	0x0104F800	The temperature of the thermal head is too high.	Turn off and on the power again. If the same problem recurs, turn off the power and consult our authorized dealers.
40	0x0104****	A hardware error has occurred.	
41	0x01051A00	Printer command is incorrect.	Please consult our authorized dealers.
	0x01052000		
42	0x01052100	A security key has already been set. A new security key cannot be specified.	-
43	0x01052200	Entry does not match the preset security key.	-
44	0x01052300	Security key has not been specified. The security lock function is not enabled.	-
45	0x01052400	Printer command is incorrect.	Please consult our authorized dealers.
	0x01052600		
46	0x01052700	Ink ribbon specification is incorrect.	Ensure that the printer driver's ink setting matches the installed ink ribbon. (☞ page 90)
47	0x01052A00	Printer command is incorrect.	Please consult our authorized dealers.
48	0x01052B00	Magnetic encoding data is incorrect.	Check the card specifications.
49	0x01052C00	IC encoder is not installed.	-
50	0x01052D00	Magnetic encoder is not installed.	-
51	0x01052E00	Optional devices are not installed.	-
52	0x0105****	A command error has occurred.	Please consult our authorized dealers.
	0x010B****		
53	0x0142A200	Retransfer film has run out.	Replace with a new one. (☞ page 33)
54	0x0142B200	Ink ribbon has run out.	Replace with a new one. (☞ page 32)

Printer Driver (Error Code:0x02000000-)

No.	Error Code	Description	Actions (Reference Page No.)
1	0x02*****	Printer is not found.	Check the printer connection.
2	0x0300274D	Printer is not found.	Check the printer connection.
		Printing using a USB-connected printer cannot be performed via Ethernet (LAN) connection.	To print via Ethernet (LAN) connection, disconnect the USB cable from the printer. (☞ page 64)
3	0x03*****	Printer is not found.	Check the printer connection.
		A communication error has occurred.	
4	0x04*****	A communication error has occurred.	Check the printer connection.
5	0x09*****	A command error has occurred.	Check the computer settings.
6	0x10000103	An error has occurred during magnetic encoding data writing.	Check the card specifications.
7	0x10000201	Contact IC encoding program is not found.	Please consult our authorized dealers.
8	0x10000202	Unable to establish communication with the contact IC encoder.	
9	0x10000203	An error has occurred during contact IC encoding data writing.	Check the card specifications.
10	0x10000301	Non-contact IC encoding program is not found.	Please consult our authorized dealers.
11	0x10000302	Unable to establish communication with the non-contact IC encoder.	
12	0x10000303	An error has occurred during non-contact IC encoding data writing.	Check the card specifications.
13	0x10000401	User program is not found.	Please consult our authorized dealers.
14	0x10000403	An error is returned for the user program.	
15	0x10000501	Magnetic encoding program is not found.	
16	0x10000503	An error has occurred during magnetic encoding data writing.	Check the card specifications.
17	0x10000504	An error has occurred during magnetic encoding data reading.	
18	0x10000505	A magnetic encoding command error has occurred.	Please consult our authorized dealers.
19	0x10000601	End notification program is not found.	
20	0x10000603	An error is returned for the end notification program.	
21	0x10001001	Ink ribbon cannot be recognized.	Ensure that the printer driver's ink setting matches the installed ink ribbon. (☞ page 90)
22	0x10001002	Ink ribbon specification is incorrect.	
23	0x10001003	IC encoder is not installed.	-
24	0x10001004	Magnetic encoder is not installed.	-
25	0x10002000	Printer is not found.	Check the printer connection.
26	0x1000200*	The printer is not ready.	-
27	0x10003000	The specified LUT file is not found.	Check the [Look up table] settings of the printer driver.
28	0x10003001	The specified LUT file cannot be opened.	
	0x10003002		
29	0x10003004	The specified UV file is not found.	Check the [UV ink] settings of the printer driver.
30	0x10003005	The specified UV file cannot be opened.	
	0x10003006		

Frequently Asked Questions

- "Printing Settings" (☞ page 128)
- "UV Ink" (☞ page 128)
- "Others" (☞ page 129)

Printing Settings

The edge of the image is not printed

- Check the printing margin setting in the application software.
- About 1 mm from the edge of the image is not printed on the card. Refer to the following diagram.

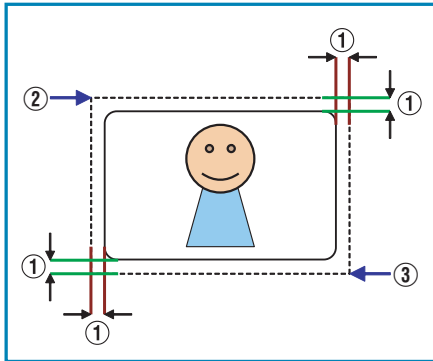

- ① About 1 mm
- ② (X=0, Y=0)
- ③ (X = approx. 87.5 mm, Y = approx. 56.0 mm)

The card is discharged without being printed

- The [Print] checkbox in the [Print] tab may not be selected. Select the [Print] checkbox.

"[Print] Tab" (☞ page 90)

How can I print black color using the Resin K ink?

- Select [2.K], [3.YMCK], [5.K+UV] or [6.YMCK+UV] for [Print mode] in the [Print] tab.

"[Print] Tab" (☞ page 90)

How can I print a card using the security erase function?

- Select [2.K], [3.YMCK], [5.K+UV] or [6.YMCK+UV] for [Print mode] in the [Print] tab, and select the [Security erase] checkbox. Doing so enables the security erase function for the Resin K ink. The security erase function is enabled when using the YMCK, YMCKK or YMCKUV ink.

For details on the settings, please consult our authorized dealers.

"[Print] Tab" (☞ page 91)

How can I store the print settings?

- Clicking [Save...] in the [Setup] tab enables you to save the print settings in a file. Clicking [Load...] in the [Setup] tab restores the print settings from the saved file.

"[Setup] Tab" (☞ page 90)

How can I print using full color conversion?

- Open the [Look up table] dialog box from the [Print] Tab and register the [look-up table file of the Color Conversion Data].

"[Look up table] Dialog Box" (☞ page 93)

UV Ink

How can I print cards using the UV ink ?

- Select [4.YMC+UV], [5.K+UV], or [6.YMCK+UV] for [Print mode] in the [Print] tab, and specify the relevant item in [UV ink...]. If UV ink is not installed into the printer, an error will occur during printing.

"[Print] Tab" (☞ page 90)

"[UV ink] Dialog Box" (☞ page 95)

Image at the top right corner is not printed

- In the case of printing using UV ink, the printer always prints the MAC address. If the "Number of retransfer film panels" in the UV ink settings is set to "1 panel", the printer will not print the image that is inside the MAC address printing area (top right or bottom left corner). Position the image so that the printing area of the YMCK ink does not overlap with that of the MAC address. If the "Number of retransfer film panels" is set to "2 panels", the printer will print the YMCK image.

"MAC Address Position" (☞ page 96)

A part of the image is not printed

- If the "Number of retransfer film panels" in the UV ink settings is set to "1 panel", the area where the UV ink overlaps with the YMC ink will not be printed. Position the image so that the printing area of the YMC ink does not overlap with that of the UV ink. If the "Number of retransfer film panels" is set to "2 panels", the printer will print the YMCK image.

"Number of retransfer film panels during printing" (☞ page 97)

How can I print images with the UV ink without the background color?

- Paint the background of the image with a specific color such as by using a graphic software. Set the color in [No printing color] of the [UV ink] dialog box. Select the background color carefully, as any color in the image that is the same as the background color will not be printed.

"No printing color" (☞ page 95)

Image using the UV ink is not printed

- The format of the image file is not supported. "Windows Bitmap File Format" (☞ page 96)
- Other application software may be using the image file.

Hidden by the Resin K ink

- If the "Number of retransfer film panels" in the UV ink settings is set to "1 panel", UV ink will not be printed at the area where it overlaps with the K ink.

Others

How can I perform magnetic/IC encoding?

- Special applications are required for methods other than inline encoding.
For more details, please consult our authorized dealers.

Printing cannot be performed through network sharing

- When the access authority of the computer is not proper, the printer may be unable to perform printing even if installation of the printer driver is completed through network sharing.
Ensure that the access authority is proper according to the instructions of the network administrator.

How can I set USB as default?

- You can fix the interface to "USB" by setting [Default Interface] in the [Printer Select] tab on the status monitor to [USB].

How can I set the IP address of the network?

- To set the network, it is necessary to connect the printer via USB and perform the setting on the status monitor.
Install the USB driver. After setting the network, remove the USB cable.

